



Cutler-Hammer

IT. S811 Soft Starter

User Manual

November 2006 — Revision 6
Supersedes June 2006 — Revision 5



November 2006

Important Notice – Please Read

The product discussed in this literature is subject to terms and conditions outlined in Eaton Electrical Inc. selling policies. The sole source governing the rights and remedies of any purchaser of this equipment is the relevant Eaton Electrical Inc. selling policy.

NO WARRANTIES, EXPRESS OR IMPLIED, INCLUDING WARRANTIES OF FITNESS FOR A PARTICULAR PURPOSE OR MERCHANTABILITY, OR WARRANTIES ARISING FROM COURSE OF DEALING OR USAGE OF TRADE, ARE MADE REGARDING THE INFORMATION, RECOMMENDATIONS AND DESCRIPTIONS CONTAINED HEREIN. In no event will Eaton Electrical Inc. be responsible to the purchaser or user in contract, in tort (including negligence), strict liability or otherwise for any special, indirect, incidental or consequential damage or loss whatsoever, including but not limited to damage or loss of use of equipment, plant or power system, cost of capital, loss of power, additional expenses in the use of existing power facilities, or claims against the purchaser or user by its customers resulting from the use of the information, recommendations and descriptions contained herein.

The information contained in this manual is subject to change without notice.

Cover Photo: The Cutler-Hammer® Intelligent Technologies (*IT.*) Soft Starter

Table of Contents

LIST OF FIGURES	iv
LIST OF TABLES	v
SAFETY	
The Meaning of Safety Statements	vii
<i>IT.</i> Soft Starter Safety Statements	viii
Dangers, Warnings, Cautions and Notes	ix
CHAPTER 1 — OVERVIEW	
General Introduction	1-1
General Appearance Notes	1-2
CHAPTER 2 — RECEIPT/UNPACKING	
General	2-1
Unpacking	2-1
Storage	2-1
CHAPTER 3 — INSTALLATION	
Mounting	3-1
Power Wiring	3-9
Control Wiring Inputs	3-14
CHAPTER 4 — SPECIFICATIONS	
Environmental	4-1
Physical	4-1
CE Conformance	4-2
Short Circuit Ratings	4-3
CHAPTER 5 — FUNCTIONAL DESCRIPTION	
Power	5-1
Control	5-1
Protection	5-4
QCPort Network Control	5-4
CHAPTER 6 — CONFIGURATION	
Programming the S811	6-1
S801 to S811 Comparison	6-2
CHAPTER 7 — SETUP AND STARTING	
Before You Begin	7-1
Setup	7-1
CHAPTER 8 — TROUBLESHOOTING	
General	8-1
Before You Begin to Troubleshoot	8-1
Define the Problem	8-2
Fault Codes	8-6
CHAPTER 9 — PARTS AND SERVICE	
Renewal Parts	9-1
Service	9-1

November 2006

Table of Contents, Continued

APPENDIX A — PARAMETERS	
Parameter List	A-1
APPENDIX B — PROTECTION	
Thermal Overload	B-1
Overload Trip Curves	B-3
S811 and Motor Protection Features	B-4
APPENDIX C — RATINGS, COOLING AND POWER LOSSES FOR A LINE CONNECTED MOTOR	
Horsepower and kW Ratings	C-1
Cooling	C-8
Power Losses	C-8
APPENDIX D — RATINGS, COOLING AND POWER LOSSES FOR AN INSIDE-THE-DELTA CONNECTED MOTOR	
Horsepower and kW Ratings	D-1
Cooling	D-8
Power Losses	D-8
APPENDIX E — MOTOR/APPLICATION CONSIDERATIONS	
Using MOVs	E-1
Squirrel Cage Motor	E-1
Wye-Delta Motor	E-2
Part Winding Motor	E-2
Dual Voltage Motor	E-2
Multi-Speed Motor	E-2
Other Winding Configurations	E-3
Power Factor Correction Capacitors	E-3
APPENDIX F — SPECIAL FUNCTION OPTIONS	
Pump Control Option	F-1
Extended Ramp Option	F-2
APPENDIX G — USER INTERFACE — DIM	
Modes of Operation	G-2
Button Operation	G-3
Areas of the Screen	G-5
Parameter Navigation/Editing	G-8
Access Level (Password) Operation	G-11
Fault Display	G-12
DIM System Configuration	G-13
DIM Setup Parameter Description	G-14
APPENDIX H — QCPORT NETWORK	
QCPort Communication Wiring	H-1
Networks	H-3
Auto and Hand/Local Modes	H-5
APPENDIX I — QCPORT PARAMETER DESCRIPTIONS	
Data Parameters	I-1
Configuration Parameters	I-6

List of Figures

Figure 1-1: The Cutler-Hammer Intelligent Technologies (IT.) S811 Soft Starter	1-2
Figure 3-1: Warning Tag	3-3
Figure 3-2: Power Wiring Alternatives	3-4
Figure 3-3: N Frame (65 mm)	3-5
Figure 3-4: R Frame (110 mm)	3-5
Figure 3-5: T Frame (200 mm)	3-6
Figure 3-6: U Frame (200 mm)	3-6
Figure 3-7: V Frame (290 mm)	3-7
Figure 3-8: EMA91 Digital Interface Module	3-7
Figure 3-9: Line Connected Soft Starter Power Wiring Diagram	3-10
Figure 3-10: Delta Connected Soft Starter Power Wiring Diagram for a 6-Lead Motor	3-11
Figure 3-11: Delta Connected Soft Starter Power Wiring Diagram for a 12-Lead Low Voltage Motor	3-11
Figure 3-12: Delta Connected Soft Starter Power Wiring Diagram for a 12-Lead High Voltage Motor	3-11
Figure 3-13: V Frame Shown with Terminal Cover Removed and EML30 Lug Kit Installed on Load Side	3-13
Figure 3-14: Terminal Block	3-14
Figure 3-15: Basic Connection Diagram for 24V DC 3-Wire Pushbutton STOP/START/JOG/RESET and 24V DC Fault/Ready and Bypass Indication	3-16
Figure 3-16: Basic Connection Diagram for 24V DC 2-Wire Switch HAND/OFF/AUTO/RESET and 24V DC Fault/Ready and Bypass Indication	3-17
Figure 3-17: Basic Connection Diagram for Use of DIM Control Only	3-17
Figure 3-18: 24V DC Control	3-22
Figure 3-19: 120V AC Control	3-22
Figure 3-20: 24V DC Control with Edge Sensing	3-24
Figure 5-1: Line Connected Soft Starter SCRs	5-1
Figure 5-2: Ramp Start	5-2
Figure 5-3: Current Limit Start	5-3
Figure 5-4: Soft Stop	5-3
Figure 6-1: Digital Interface Module (DIM) — Display Mode	6-1
Figure 6-2: Digital Interface Module (DIM) — Parameter Edit Mode	6-2
Figure 8-1: Start Command Troubleshooting Flowchart	8-2
Figure 8-2: Main Troubleshooting Flowchart #1	8-4
Figure A-1: Navigation Overview	A-1
Figure B-1: Overload Trip Curves	B-3
Figure F-1: IT. Soft Starter DIM	F-1
Figure F-2: Pump Start Ramp and Soft Pump Stop	F-2
Figure G-1: DIM (Digital Interface Module)	G-1
Figure G-2: Display Mode LCD	G-2
Figure G-3: Parameter Edit Mode LCD	G-2
Figure G-4: Fault Mode LCD	G-2
Figure G-5: Soft Key Functions Above Soft Keys	G-3
Figure G-6: Predefined Keys	G-4
Figure G-7: Status Bar on LCD	G-5
Figure G-8: Device Connection (User Display Only)	G-5
Figure G-9: Connection Status	G-5
Figure G-10: Mode of Operation	G-6
Figure G-11: Connection Destination	G-7
Figure G-12: HAND/AUTO Status	G-7

November 2006

List of Figures, Continued

Figure G-13: Motor Control Status	G-7
Figure G-14: Bar Indicates Menu Position	G-8
Figure G-15: Bar Indicates Item Position	G-8
Figure G-16: Bar Indicates Edited Value	G-9
Figure G-17: Use MORE to Highlight Element	G-10
Figure G-18: Setting Access Level	G-11
Figure G-19: Changing Passwords	G-12
Figure G-20: Fault Display	G-12
Figure H-1: QCP Network Wiring	H-2
Figure H-2: Two-Wire QCPort System	H-3
Figure H-3: Three-Wire QCPort System	H-4
Figure H-4: S811 Motor Control Byte	H-6

List of Tables

Table 3-1: Required Mounting Hardware	3-8
Table 3-2: Weight Support Requirements	3-8
Table 3-3: Line and Load Power Wiring	3-12
Table 3-4: 12-Pin Terminal Block Wiring Capacity	3-14
Table 3-5: S811 Terminal Block Control Wiring	3-15
Table 3-6: 24V DC Power Supply Requirements	3-18
Table 3-7: 24V DC Power Supplies	3-19
Table 4-1: Environmental Specifications	4-1
Table 4-2: Weight	4-1
Table 4-3: Agency Standards and Certifications	4-1
Table 4-4: EMC Immunity	4-2
Table 4-5: Short Circuit Ratings	4-3
Table 6-1: S801 to S811 Setup Cross-Reference	6-2
Table 8-1: Start Command Troubleshooting	8-3
Table 8-2: Troubleshooting – Status LED OFF	8-5
Table 8-3: Troubleshooting – Status LED GREEN	8-5
Table 8-4: Troubleshooting Fault Table	8-6
Table 8-5: Resetting the S811	8-8
Table 9-1: DIM – Digital Interface Module Renewal Parts	9-1
Table A-1: Monitoring — Menu 1	A-2
Table A-2: Diagnostics — Menu 2	A-3
Table A-3: Soft Start Config — Menu 3	A-4
Table A-4: Overload Config — Menu 4	A-5
Table A-5: Protection Setup — Menu 5	A-6
Table A-6: Network Setup — Menu 6	A-7
Table A-7: Network Status — Menu 7	A-8
Table A-8: LCD DIM Setup Menu	A-9
Table B-1: Overload — Adjustment Settings	B-1
Table B-2: Thermal Motor Overload Times	B-2
Table B-3: Motor Parameters Required for Protection	B-4
Table B-4: Instantaneous Over Current Settings	B-4
Table B-5: Motor Stall Settings	B-4
Table B-6: SCR Over Current Settings	B-4
Table B-7: Motor Jam Settings	B-5
Table B-8: Motor Over Current Settings	B-5
Table B-9: Motor Under Load Settings	B-5
Table B-10: Current Imbalance Settings	B-5

List of Tables, Continued

Table B-11: Phase Loss Settings	B-6
Table B-12: Motor Voltage Phase Reversal Settings	B-6
Table B-13: Voltage Imbalance Settings	B-6
Table B-14: Under Voltage Settings	B-7
Table B-15: Over Voltage Settings	B-7
Table B-16: Fault Generation	B-7
Table B-17: S811 Protection Faults	B-8
Table C-1: 15 Second Ramp, 4 Starts per Hour, 300% Current Limit @ 40°C	C-1
Table C-2: 25 Second Ramp, 4 Starts per Hour, 300% Current Limit @ 40°C	C-2
Table C-3: 15 Second Ramp, 4 Starts per Hour, 300% Current Limit @ 50°C	C-3
Table C-4: 50 Second Ramp, 2 Starts per Hour, 300% Current Limit @ 50°C	C-4
Table C-5: 15 Second Ramp, 4 Starts per Hour, 450% Current Limit @ 40°C	C-5
Table C-6: 30 Second Ramp, 4 Starts per Hour, 450% Current Limit @ 40°C	C-6
Table C-7: > 30 Second Ramp, > 4 Starts per Hour or >300% Current Limit	C-7
Table C-8: Maximum Power Loss	C-8
Table D-1: 15 Second Ramp, 4 Starts per Hour, 300% Current Limit @ 40°C Ambient	D-1
Table D-2: 25 Second Ramp, 4 Starts per Hour, 300% Current Limit @ 40°C Ambient	D-2
Table D-3: 15 Second Ramp, 4 Starts per Hour, 300% Current Limit @ 50°C Ambient	D-3
Table D-4: 50 Second Ramp, 2 Starts per Hour, 300% Current Limit @ 50°C Ambient	D-4
Table D-5: 15 Second Ramp, 4 Starts per Hour, 450% Current Limit @ 40°C Ambient	D-5
Table D-6: 30 Second Ramp, 4 Starts per Hour, 450% Current Limit @ 40°C Ambient	D-6
Table D-7: Severe Duty Inside-the-Delta Ratings	D-7
Table D-8: Maximum Power Loss	D-8
Table E-1: MOV Kit Options	E-1
Table G-1: Access Levels	G-11
Table G-2: Reconfiguring All Devices	G-13
Table G-3: LCD DIM Setup Menu Access	G-14

November 2006

Safety

Eaton’s electrical business has made every effort to provide you with the safest motor starters on the market. However, we wish to point out how to safely operate and troubleshoot your starter.

The Meaning of Safety Statements

You will find various types of safety information on the following pages and on the labels attached to the equipment. This section explains their meaning.











The Safety Alert Symbol means **ATTENTION! BECOME ALERT! YOUR SAFETY IS INVOLVED!**



Le symbole d’alerte signifie **ATTENTION ! SOYEZ VIGILANT ! VOTRE SECURITE EST EN JEU !**









El símbolo de alerta de seguridad significa **¡ATENCIÓN! ¡ESTÉ ALERTA! ¡SU SEGURIDAD ESTÁ EN JUEGO!**

 Danger	 Danger	 Peligro
Danger means that failure to follow the safety statement will result in serious personal injury, death, or substantial property damage.	Danger signifie que l’inobservation de l’énoncé de sécurité entraînera des blessures corporelles graves, la mort ou des dégâts matériels substantiels.	Peligro significa que si no se respeta la indicación de seguridad, se producirán lesiones personales graves, la muerte o daño considerable a la propiedad.
 Warning	 Avertissement	 Advertencia
Warning means that failure to follow the safety statement could result in serious personal injury, death, or substantial property damage.	Avertissement signifie que l’inobservation de l’énoncé de sécurité pourrait entraîner des blessures corporelles graves, la mort ou des dégâts matériels substantiels.	Advertencia significa que si no se respeta la indicación de seguridad se pueden producir lesiones personales graves, la muerte o daños considerables a la propiedad.
 Caution	 Attention	 Precaución
Caution means that failure to follow the safety statement may result in minor or moderate personal injury or property damage.	Attention signifie que l’inobservation de l’énoncé de sécurité peut entraîner des blessures corporelles mineures ou modérés ou des dégâts matériels.	Precaución significa que si no se respeta la indicación de seguridad, se pueden producir lesiones personales menores o moderadas, o daños a la propiedad.
Notice	Avis	Aviso
Notice means that failure to follow these instructions could cause damage to the equipment or cause it to operate improperly.	Avis signifie que l’inobservation de ses instructions pourrait entraîner des dégâts à ou le mauvais fonctionnement de l’équipement.	Aviso significa que si no se siguen estas instrucciones, se pueden producir daños al equipo o provocar que funcione de manera incorrecta.

IT. Soft Starter Safety Statements







The following safety statements relate to the installation, operation and troubleshooting of Cutler-Hammer® Motor Starters.

Notice	Avis	Aviso
Make sure you read and understand the procedures in this manual before you attempt to operate or set up the equipment.	Bien lire et comprendre les procédures contenues dans ce manuel avant de tenter le fonctionnement ou la mise en place de l'équipement.	Asegúrese de leer y entender los procedimientos en este manual antes de intentar operar o configurar el equipo.
 Warning	 Avertissement	 Advertencia
This instruction manual should be used for proper installation, setup and operation of the starter. Improperly installing and maintaining this product can result in serious personal injury or property damage. Before attempting installation, setup or operation, read and understand all of this manual.	Ce manuel d'instructions doit être utilisé pour l'installation, mise en place et opération réglés d'un démarreur. La mauvaise installation et entretien de ses produits pourraient entraîner des blessures corporelles graves ou des dommages matériels. Avant de tenter l'installation ou l'entretien, bien lire et comprendre ce manuel en entier.	Este manual de instrucciones debe utilizarse para la correcta instalación, configuración y operación del arrancador. La instalación o el mantenimiento inadecuado de este producto puede ocasionar serias lesiones personales o daños al material. Antes de intentar la instalación, la configuración o la operación lea y entienda todo el manual.
 Danger High Voltage	 Danger Haute Tension	 Peligro alto voltaje
There can be line voltage potential at the motor load terminals even with the starter in the OFF state. This is due to the possible leakage across the thyristors. Unit does not provide galvanic isolation. Always disconnect input power before servicing the starter or motor.	Il peut exister une tension de ligne potentielle aux bornes de charge du moteur bien que le démarreur soit dans en état d'arrêt. Cela s'explique du fait de fuites possibles à travers les redresseurs au silicium. Le produit ne fournit pas l'isolement galvanique. Toujours débrancher l'alimentation avant de travailler sur le démarreur ou le moteur.	Aun con el motor desactivado, puede haber voltaje de línea en los terminales de la carga del motor. Esto se debe a una posible fuga a través de los tiristores. La unidad no brinda aislamiento galvánico. Desconecte siempre la alimentación antes de trabajar sobre el arrancador o el motor.
Notice	Avis	Aviso
Power factor capacitors: Do not connect power factor correcting capacitors to the load side of the starter. They will cause the starter to fail. If capacitors are used, they must be connected to the line side of the starter, as far upstream as possible.	Condensateurs de compensation : Ne pas raccorder ces appareils au côté charge du démarreur. Cela entraînera la défaillance du démarreur. Si des condensateurs sont utilisés, ils doivent être raccorder au côté ligne du démarreur, aussi loin amont que possible.	Capacitores correctores del factor de potencia: No conecte estos capacitores del lado de la carga del arrancador. Esto ocasionará la falla de este último. Si se usan capacitores, deben conectarse del lado de la línea del arrancador, tan lejos de la entrada como sea posible.







November 2006

Dangers, Warnings, Cautions and Notes







Dangers

 Danger High Voltage	 Danger Haute Tension	 Peligro alto voltaje
<p>Hazardous voltage can cause electric shock and burns. To avoid shock hazard, disconnect all power to the controller, motor or other control devices before any work is performed on this equipment. Failure to do so will result in personal injury, death or substantial property damage.</p>	<p>Une tension électrique dangereuse peut causer des chocs électriques et des brûlures. Pour éviter des chocs électriques, débrancher l'alimentation du contrôleur, du moteur ou des autres appareils de contrôle avant d'y effectuer du travail. L'inobservation de ces instructions entraînera des blessures corporelles graves, la mort ou des dégâts matériels substantiels.</p>	<p>Voltajes peligrosos que pueden causar descargas eléctricas y quemaduras. Para evitar descargas eléctricas, desconecte la alimentación del controlador, del motor u otros dispositivos de control antes de efectuar cualquier trabajo en el equipo. El incumplimiento de estas medidas ocasionará lesiones personales, la muerte o daños importantes al material.</p>
<p>Do not apply a disconnect device on the output of the <i>IT</i>. Soft Starter unless a means to turn off the soft starter when disconnect switch is open is utilized. Opening disconnect while the <i>IT</i>. Soft Starter is operating may cause a malfunction. Closing disconnect switch while the <i>IT</i>. Soft Starter is operating will result in a soft starter failure and potential equipment damage and personnel hazard.</p>	<p>Ne pas appliquer un appareil de sectionnement sur la sortie du démarreur progressif <i>IT</i>. à moins qu'un moyen d'éteindre le démarreur progressif quand l'interrupteur de sectionnement est ouvert soit utilisé. Le fait d'ouvrir l'interrupteur de sectionnement pendant le fonctionnement du démarreur progressif <i>IT</i>. peut entraîner une défaillance. Le fait d'éteindre l'interrupteur de sectionnement pendant le fonctionnement du démarreur progressif <i>IT</i>. entraînera la défaillance du démarreur progressif et des dégâts à l'équipement ou risque au personnel.</p>	<p>No aplique un dispositivo de desconexión a la salida del arrancador <i>IT</i>. Soft Starter a menos que se utilice un medio para apagar el arrancador cuando el interruptor de desconexión está abierto. La apertura del interruptor de desconexión mientras el arrancador <i>IT</i>. está operando puede ocasionar un funcionamiento incorrecto. El cierre del interruptor de desconexión mientras el arrancador <i>IT</i>. está operando producirá una falla de dicho arrancador, como también potenciales daños a los equipos y riesgo para el personal.</p>
 Danger High Voltage	 Danger Haute Tension	 Peligro alto voltaje
<p>Hazardous voltage can cause electric shock and burns. Always disconnect power before proceeding with any work on this product.</p>	<p>Une tension électrique dangereuse peut causer des chocs électriques et des brûlures. Il faut toujours débrancher l'alimentation électrique avant de travailler sur ce produit.</p>	<p>Voltajes peligrosos que pueden causar descargas eléctricas y quemaduras. Siempre desconecte la energía eléctrica antes de efectuar cualquier trabajo en el equipo.</p>

Dangers, continued









 Danger High Voltage	 Danger Haute Tension	 Peligro alto voltaje
The S811 has the ability to respond to commands from an automated network controller. Consequently the soft starter may start unexpectedly in response to these commands. To insure the safety of personnel and equipment, always remove power before accessing the electrical and/or mechanical equipment.	Le S811 à la capacité de répondre aux commandes d'un contrôleur de réseau automatisé. Donc le démarreur progressif peut démarrer soudainement en réponse à ces commandes. Pour s'assurer la sécurité du personnel et de l'équipement, toujours débrancher l'alimentation avant d'accéder à l'équipement électrique et/ou mécanique.	El S811 tiene la capacidad de responder a comandos de un controlador de red automatizado. Por lo tanto, el arrancador suave podría arrancar de improviso en respuesta a estos comandos. Para garantizar la seguridad del personal y del equipo, siempre desconecte la energía antes de acceder al equipo eléctrico o mecánico.
 Danger High Voltage	 Danger Haute Tension	 Peligro alto voltaje
Do not work on energized equipment unless absolutely required. If troubleshooting procedure requires equipment to be energized, all work must be performed by properly qualified personnel, following appropriate safety practices and precautionary measures.	Ne pas travailler sur d'équipement sous tension sauf si c'est absolument nécessaire. Si des méthodes de dépannage exigent que l'équipement soit sous tension, tout travail doit être fait par du personnel qualifié, suivant des pratiques de sécurité et des mesures de précaution appropriées.	No trabaje en equipos en funcionamiento, a menos que sea absolutamente necesario. Si un procedimiento de solución de problemas requiere que el equipo permanezca encendido, todo el trabajo lo debe realizar personal adecuadamente calificado, respetando las prácticas de seguridad y las medidas preventivas correspondientes.

Warnings

 Warning	 Avertissement	 Advertencia
After mounting the unit, remove and discard the lifting eye and packaging bolts before continuing with the installation process.	Après que l'appareil sera supporté, enlever et jeter les œillets de levage et les boulons de l'emballage avant de poursuivre l'installation.	Después de montar la unidad, retire y elimine la argolla de izada y los pernos de embalaje antes de continuar con el proceso de instalación.
 Warning	 Avertissement	 Advertencia
Make sure you read and understand all of the safety statements in the safety section of this manual before you begin troubleshooting.	S'assurer de bien lire et comprendre les énoncés de sécurité de ce manuel avant de commencer le dépannage.	Antes de comenzar a solucionar problemas, asegúrese de leer y comprender todas las indicaciones de seguridad que aparecen en la sección de seguridad de este manual.

November 2006

Cautions

 Caution	 Attention	 Precaución
<p>The S811V soft starter weighs approximately 100 Lbs. (45 kg). To prevent personal injury or equipment damage, use proper lifting equipment (such as a floor crane) to safely lift and install the soft starter. A lifting eye is provided at the line end of the soft starter.</p>	<p>Le démarreur progressif S811V pèse environ 45 kg (100 livres). Pour éviter des blessures corporelles ou des dégâts matériels, utiliser une machine de levage appropriée (comme une grue d’atelier) pour soulever et installer le démarreur progressif sans encombre. Un œillet de levage est prévu au côté ligne du démarreur progressif.</p>	<p>El arrancador suave S811V pesa aproximadamente 45 kg (100 lb.). Para evitar que se produzcan lesiones personales o daños al equipo, use el equipo para elevar adecuado (como un brazo de elevación) a fin de levantar e instalar con seguridad el arrancador suave. Se proporciona una argolla de izada en el extremo de del arrancador suave.</p>
<p> Caution</p> <p>Only apply 24V DC to the terminal block unless specified otherwise in this manual. All control wiring is 22 – 12 AWG (0.33 – 2.5 mm²). Failure to follow this caution could result in severe damage to the controller.</p>	<p> Attention</p> <p>Appliquer seulement 24V CC à la barrette à bornes sauf ce manuel offre d’avis contraire. Tout le câblage de commande est de calibre 0,33 – 2,5 mm² (22 – 12 AWG). L’inobservation de cet énoncé pourrait entraîner des dégâts matériels au contrôleur.</p>	<p> Precaución</p> <p>Aplique sólo 24 V CC al bloque de terminales, a menos que se especifique lo contrario en este manual. Todo el cableado de control es de 0.33 – 2.5 mm² (22 – 12 AWG). Si no respeta esta precaución, se pueden producir daños graves al controlador.</p>
<p> Caution</p> <p>Never megger a motor while it is connected to the <i>IT</i>. Soft Starter. Disconnect the leads at the <i>IT</i>. Soft Starter before meggering the motor.</p>	<p> Attention</p> <p>Ne jamais régler un moteur alors qu’il est branché au démarreur progressif <i>IT</i>. Débrancher les fils au démarreur progressif <i>IT</i>. Avant de régler le moteur.</p>	<p> Precaución</p> <p>Nunca efectúe pruebas del motor con un megóhmetro mientras esté conectado al arrancador Soft Starter <i>IT</i>. Desconecte los cables en el arrancador <i>IT</i>. antes de usar el megóhmetro.</p>

Notes

Notice	Avis	Aviso
<p>The S811V Soft Starter includes mounting hardware (8 1/4-20 x 1.5 Allen hex head cap screws and special washers). Do not substitute for this hardware. See Figure 3-7 on Page 3-7 for panel hole locations. Applicable codes or standards must be considered before locating and mounting the soft starter. The four special rectangular/rounded washers must be used on the two innermost mounting holes on both the line and load side of the soft starter.</p>	<p>Le démarreur progressif S811V inclut des matériels de support (vis à tête hexagonale 8-1/4-20 x 1,5 et des rondelles spéciales). Ne substituer pas pour ces matériels. Consulter la Figure 3-7 de la Page 3-7 pour les locations des trous dans le panneau. Tenir compte des normes et des codes existants avant de localiser et de monter le démarreur progressif. Les quatre rondelles rectangulaires/circulaires spéciales doivent être utiliser aux deux trous de support les plus intérieurs sur le côté ligne et le côté charge du démarreur progressif.</p>	<p>El arrancador suave S811V incluye piezas metálicas de montaje (tornillos Allen de cabeza hexagonal de 8 1/4-20 x 1.5 y arandelas especiales). No las sustituya. Consulte la Figura 3-7 que aparece en la página 3-7 para conocer las ubicaciones de los orificios del panel. Antes de ubicar y montar el arrancador suave, se deben considerar los códigos o las normas pertinentes. Las cuatro arandelas rectangulares/redondas especiales se deben usar en los dos orificios de montaje que se encuentren más al interior, en los lados de línea y de carga del arrancador suave.</p>

November 2006

Chapter 1 — Overview

General Introduction

The Cutler-Hammer® Intelligent Technologies S811 *IT*. Soft Starter from Eaton's electrical business is an electronic, self-contained, panel- or enclosure-mounted motor soft-starting device. It is intended to provide three-phase induction motors with a smooth start, both mechanically and electrically. The S811 Soft Starters utilize six SCRs connected in a full wave power bridge. Varying the SCR conduction period controls the voltage applied to the motor. This in turn controls the torque developed by the motor. After the motor reaches speed, contacts are closed to bypass the SCRs.

The S811 has built-in communications capabilities through Cutler-Hammer QC (Quick Connect) Port. The S811 Soft Starter utilizes a DIM (Digital Interface Module) that allows the user to configure the device and read system parameters. The DIM includes an easy-to-read LCD display and keypad to scroll through the menus. The DIM allows the user to modify control parameters, enable or disable protections, set communication variables, monitor system parameters such as line voltages and currents and access the fault queue.

The S811 is designed to fulfill the industrial service requirements for applications such as Chillers, Pumps and Machine Tools that require less than 85% of the motor's rated starting torque for worst case starting condition.

The S811 meets all relevant specifications set forth by NEMA ICS 1, ICS 2 and ICS 5, UL 508, IEC 60947-4-2, CE and CSA.

This user manual covers everything you need to know in order to install, set up, operate, troubleshoot and maintain the S811.

However, no publication can take into account every possible situation. If you require further assistance with any aspect of this product, or a particular application, please contact us.

For contact information, please see **Chapter 9**.

General Appearance Notes

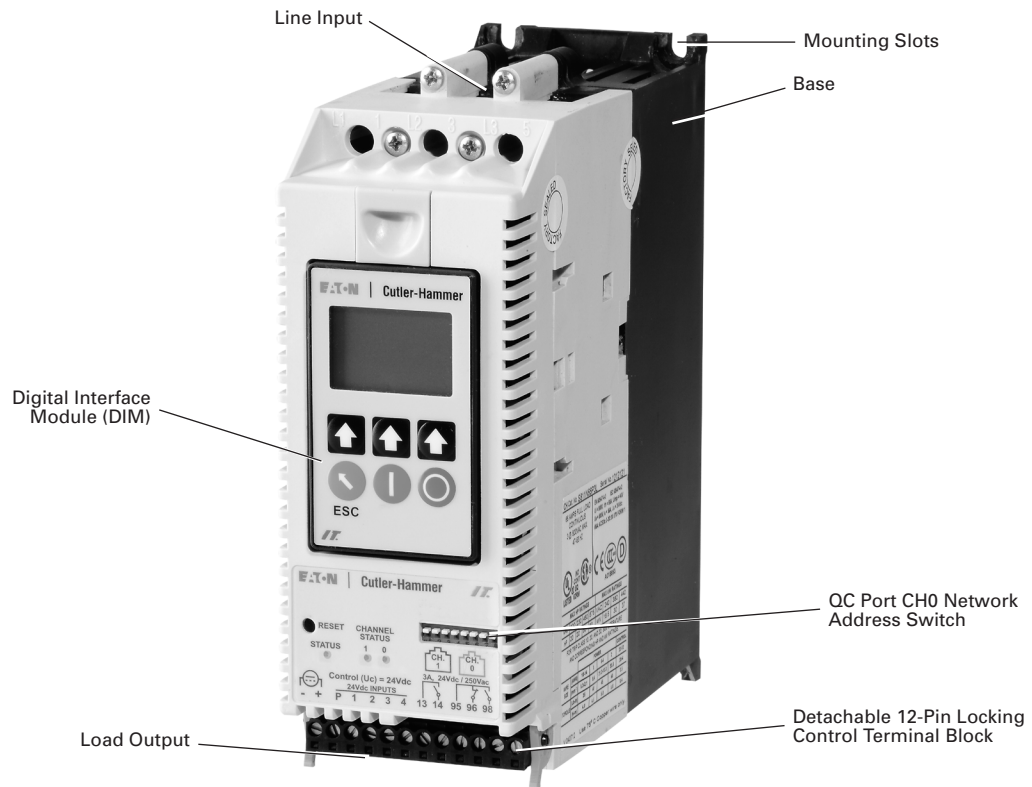

Figure 1-1: The Cutler-Hammer Intelligent Technologies (IT.) S811 Soft Starter

November 2006

Chapter 2 — Receipt/Unpacking

General

Upon receipt of the unit, verify that the catalog number and unit options stated on the shipping container match those stated on the order/purchase form.

Inspect the equipment upon delivery. Report any crate or carton damage to the carrier prior to accepting the delivery. Have this information noted on the freight bill. Eaton is not responsible for damage incurred in shipping.

Unpacking

Remove all packing material from the unit. Be sure to remove all packing material from lug locations. Also, make sure no packing material blocks the airflow near the fans. For V frame units, verify mounting hardware has been included with shipment.

Check the unit for any signs of shipping damage. If damage is found after unpacking, report it to the freight company. Retain the packaging materials for carrier to review.

Verify that the unit's catalog number and options match those stated on the order/purchase form.

Storage

It is recommended that the unit be stored in its original shipping box/crate until it is to be installed.

The unit should be stored in a location where:

- The ambient temperature is -58°F – 158°F (-50°C – 70°C)
- The relative humidity is 0% – 95%, non-condensing
- The environment is dry, clean and non-corrosive
- The unit will not be subjected to high shock or vibration conditions

November 2006

Chapter 3 — Installation

Mounting

Models S811N, S811R and S811T

The S811 is easy to mount. It does not require any special tools.

To aid you with panel layout, refer to the dimension drawings in **Figures 3-3** through **3-7** of this manual. Drill and tap holes per mounting hole location as shown.

To mount the unit, use all the hardware specified in **Table 3-1** on **Page 3-8**. Tighten to the torque specified.

The T frame S811 is supplied with a lifting eye mounted on the center phase of the line end of the device. This will aid in mounting the unit.

 Warning	 Avertissement	 Advertencia
After mounting the unit, remove and discard the lifting eye and packaging bolts before continuing with the installation process.	Après que l'appareil sera supporté, enlever et jeter les œillets de levage et les boulons de l'emballage avant de poursuivre l'installation.	Después de montar la unidad, retire y elimine la argolla de izada y los pernos de embalaje antes de continuar con el proceso de instalación.

Model S811V10

IMPORTANT: For model S811V10xxx, see additional installation requirements noted on **Page 3-4**.

 Caution	 Attention	 Precaución
The S811V soft starter weighs approximately 100 Lbs. (45 kg). To prevent personal injury or equipment damage, use proper lifting equipment (such as a floor crane) to safely lift and install the soft starter. A lifting eye is provided at the line end of the soft starter.	Le démarreur progressif S811V pèse environ 45kg (100 livres). Pour éviter des blessures corporelles ou des dégâts matériels, utiliser une machine de levage appropriée (comme une grue d'atelier) pour soulever et installer le démarreur progressif sans encombre. Un œillet de levage est prévu au côté ligne du démarreur progressif.	El arrancador suave S811V pesa aproximadamente 45 kg (100 lb.). Para evitar que se produzcan lesiones personales o daños al equipo, use el equipo para elevar adecuado (como un brazo de elevación) a fin de levantar e instalar con seguridad el arrancador suave. Se proporciona una argolla de izada en el extremo de del arrancador suave.

Notice	Avis	Aviso
<p>The S811V soft starter includes mounting hardware (8 1/4-20 x 1.5 Allen hex head cap screws and special washers). Do not substitute for this hardware. See Figure 3-7 on Page 3-7 for panel hole locations. Applicable codes or standards must be considered before locating and mounting the soft starter. The four special rectangular/rounded washers must be used on the two innermost mounting holes on both the line and load side of the soft starter.</p>	<p>Le démarreur progressif S811V inclut des matériels de support (vis à tête hexagonale 8-1/4-20 x 1,5 et des rondelles spéciales). Ne substituer pas pour ces matériels. Consulter la Figure 3-7 de la Page 3-7 pour les locations des trous dans le panneau. Tenir compte des normes et des codes existants avant de localiser et de monter le démarreur progressif. Les quatre rondelles rectangulaires/circulaires spéciales doivent être utiliser aux deux trous de support les plus intérieurs sur le côté ligne et le côté charge du démarreur progressif.</p>	<p>El arrancador suave S811V incluye piezas metálicas de montaje (tornillos Allen de cabeza hexagonal de 8 1/4-20 x 1.5 y arandelas especiales). No las sustituya. Consulte la Figura 3-7 que aparece en la página 3-7 para conocer las ubicaciones de los orificios del panel. Antes de ubicar y montar el arrancador suave, se deben considerar los códigos o las normas pertinentes. Las cuatro arandelas rectangulares/redondas especiales se deben usar en los dos orificios de montaje que se encuentren más al interior, en los lados de línea y de carga del arrancador suave.</p>

Drill and tap the eight mounting holes. Thread the two lower middle screws (with special flat washer and lockwasher) into the panel before lifting the soft starter. These two screws will assist in mounting. Special mounting hardware is included with the soft starter. Hardware supplied must be used.

Hook lifting equipment to the soft starter lifting eye. If you are using a crane, minimize the chain length between the boom and the soft starter. Make sure that the back of the soft starter is oriented to the panel-mounting surface. Make sure that the lifting equipment hook is fully engaged with the soft starter lifting eye before lifting.

Slowly lift the soft starter to about 2 in. (5 cm) above the mounting location. Then move it back against the mounting panel. Carefully lower the soft starter onto the two mounting screws. Make sure the screws align with the slots on the load end of the soft starter, and that the two washers are between the soft starter base and the screw head.

Install and tighten the remaining six mounting screws, washers and lockwashers. Then tighten the two lower middle screws. Tighten all eight screws to 50 Lb-in (5.6 N•m). Disengage and remove the lifting equipment.

 Warning	 Avertissement	 Advertencia
<p>After mounting the unit, remove and discard the lifting eye and packaging bolts before continuing with the installation process.</p>	<p>Après que l'appareil sera supporté, enlever et jeter les œillets de levage et les boulons de l'emballage avant de poursuivre l'installation.</p>	<p>Después de montar la unidad, retire y elimine la argolla de izada y los pernos de embalaje antes de continuar con el proceso de instalación.</p>

November 2006



Figure 3-1: Warning Tag

S811V10xxx Installation Requirements

1. Install the device in a minimum enclosure size 30 ft³.
2. Two (2) forced air ventilation fans with a min. 500 ft³/min, at a location for “air in” — bottom right or left corner and “air out” — opposite upper right or left corner.
3. RD circuit breaker.
4. For power wiring: Use four (4) 500 MCM cables for each phase between RD circuit breaker and Soft Starter.

OPTIONAL: Two (2) 3" x 1/4" bus with a 1/4" spacer per terminal.

Note: See **Figure 3-2** for alternative layouts.

5. Line and load service entrance wiring must not cross in the enclosure.

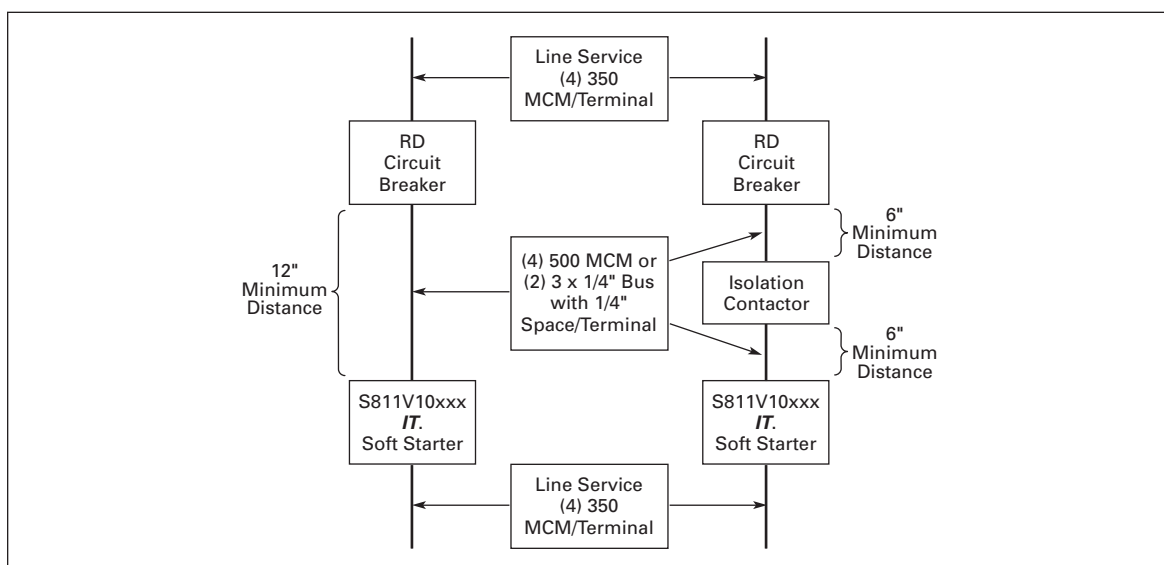

Figure 3-2: Power Wiring Alternatives

November 2006

Dimensions

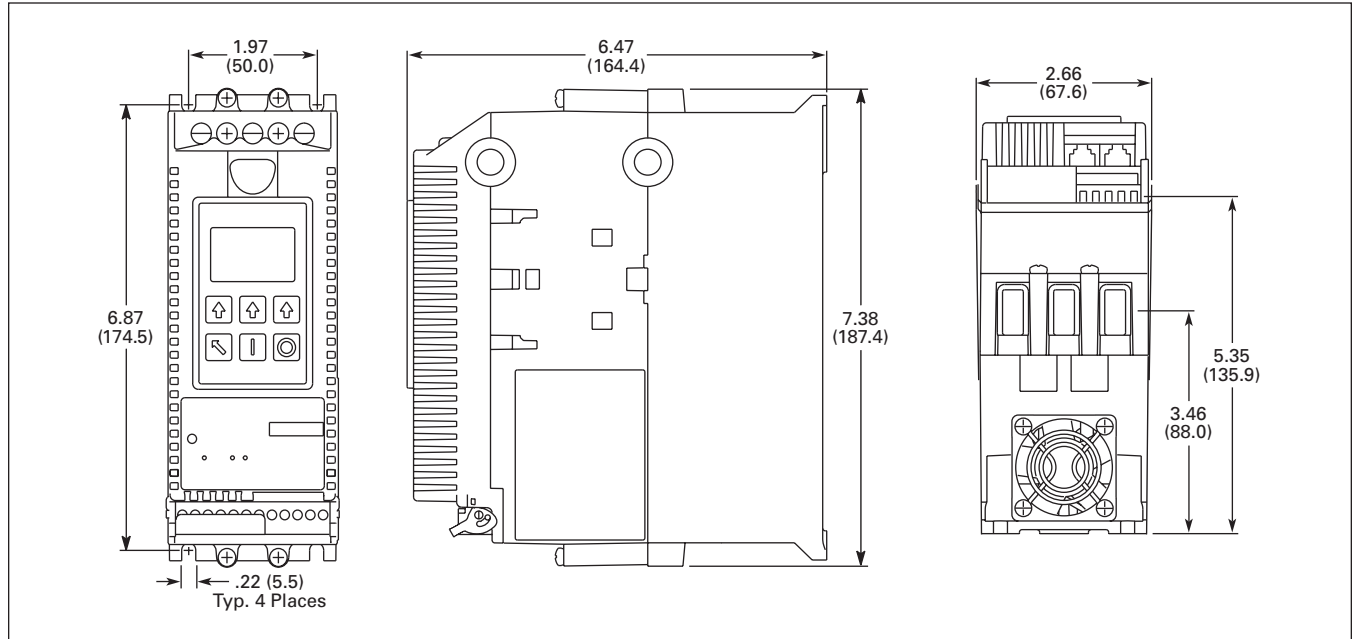

Figure 3-3: N Frame (65 mm)
Approximate Dimensions in Inches (mm)

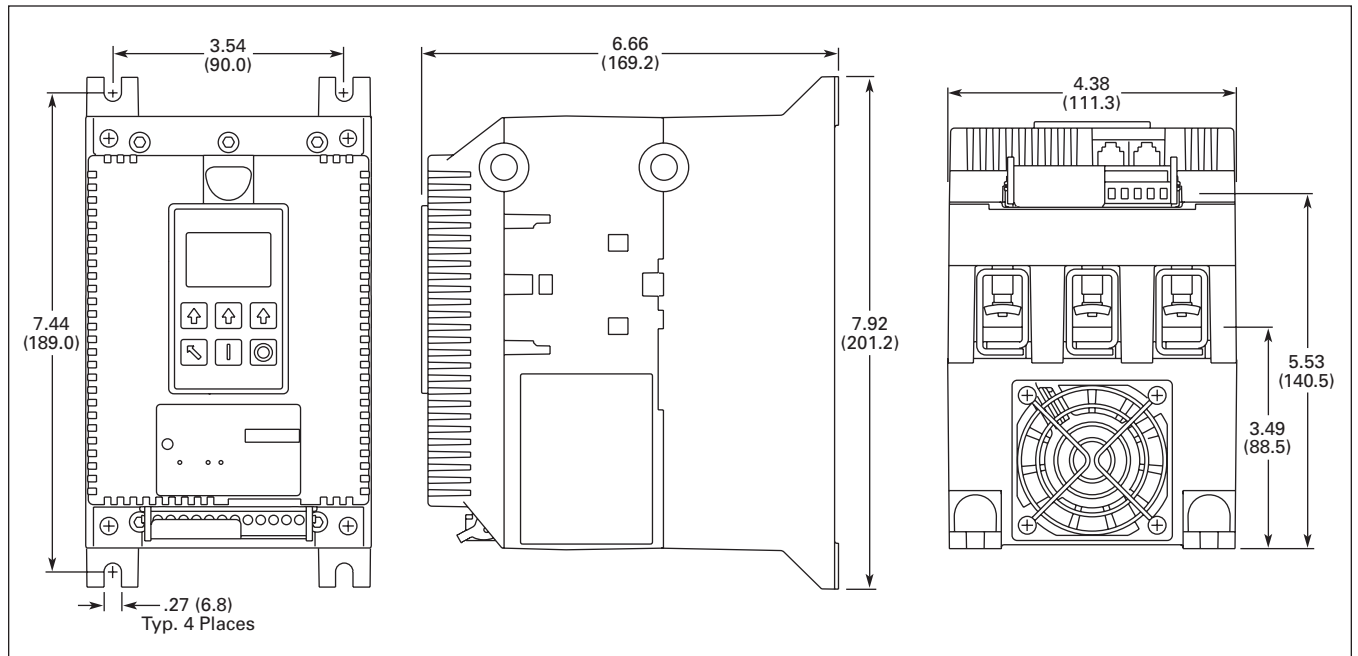

Figure 3-4: R Frame (110 mm)
Approximate Dimensions in Inches (mm)

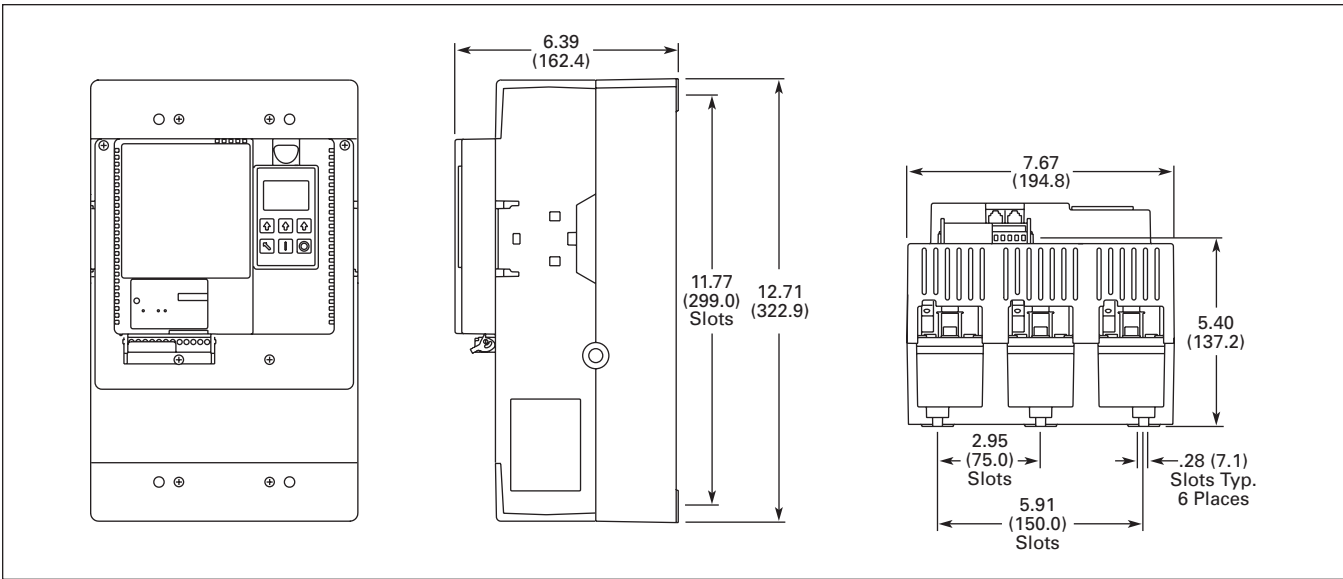

Figure 3-5: T Frame (200 mm)
Approximate Dimensions in Inches (mm)

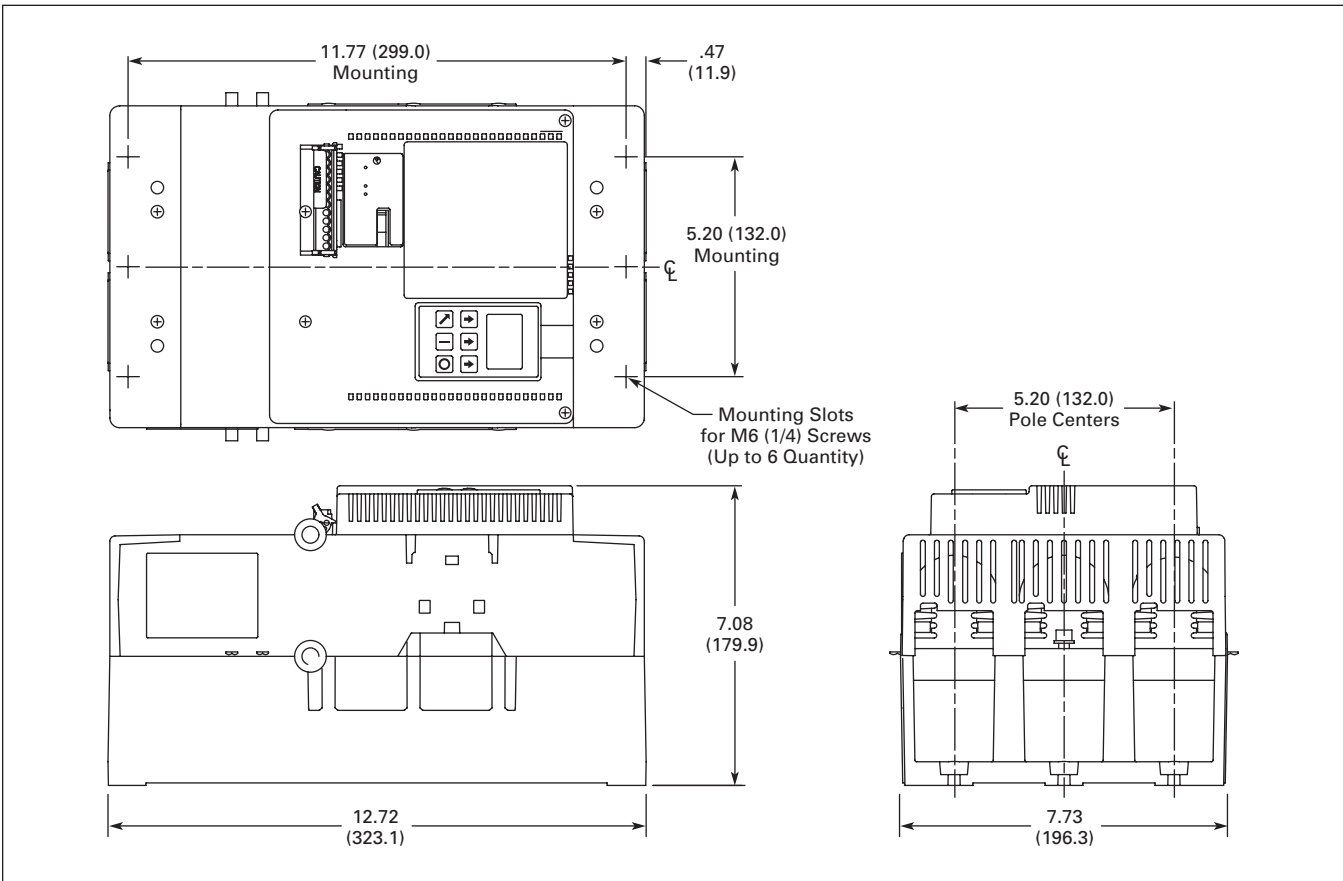

Figure 3-6: U Frame (200 mm)
Approximate Dimensions in Inches (mm)

November 2006

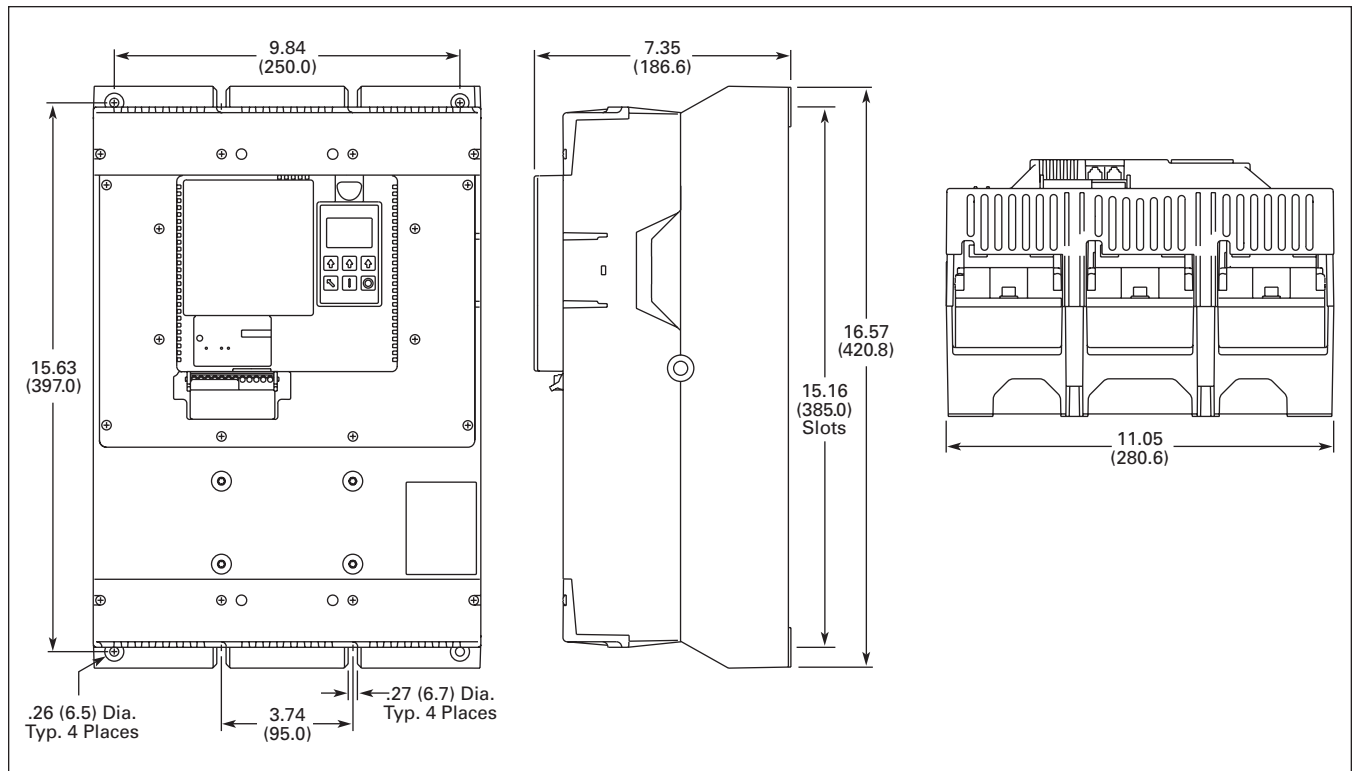

Figure 3-7: V Frame (290 mm)
Approximate Dimensions in Inches (mm)

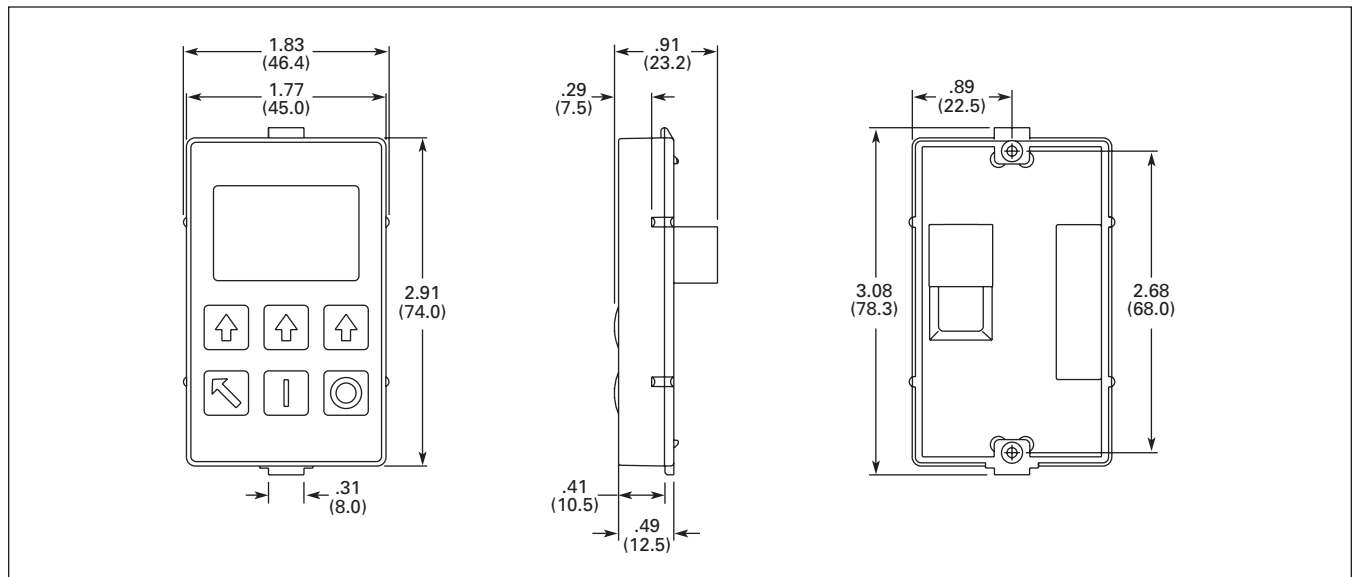

Figure 3-8: EMA91 Digital Interface Module
Approximate Dimensions in Inches (mm)

Required Mounting Hardware

Table 3-1: Required Mounting Hardware

Frame Size	Screw Size	Washer Size	Quantity Required	Torque Required
N	#10 – 32 x 0.5	Standard #10 Lockwasher and Flat Washer	4	15 Lb-in (1.7 N•m)
R	1/4 – 20 x 0.625	Standard 1/4 Lockwasher and Flat Washer	4	25 Lb-in (2.8 N•m)
T & U	1/4 – 20 x 0.625	Standard 1/4 Lockwasher and Flat Washer	6	30 Lb-in (3.4 N•m)
V	1/4 – 20 x 1.5 Grade 8 Allen head hex cap screws	Quantity: 4 ID: 0.270 OD: 0.495 – 0.505 Max. 0.055 Thick	8	50 Lb-in (5.6 N•m)
		Quantity: 4 Special Washer		
Included with V Frame Units				

Weight Support Requirements

Table 3-2: Weight Support Requirements

Frame Size	Weight of Unit
N	5.8 Lbs. (2.6 Kg)
R	10.5 Lbs. (4.8 Kg)
T & U	48 Lbs. (21.8 Kg) with lugs
	41 Lbs. (18.6 Kg) without lugs
V	103 Lbs. (46.8 Kg) with lugs
	91 Lbs. (41.4 Kg) without lugs



November 2006

Power Wiring

Using the wiring diagrams in **Figures 3-9 – 3-12, 3-15, 3-16 and 3-17** and **Table 3-3** below as guides, connect the line, Motor, and Power Supply wiring in accordance with appropriate local and national codes.

Note: To provide optimum motor protection the Line and Motor power wiring should be tightly bundled and run perpendicular to the orientation of the S811.

Safety Notices

 Danger High Voltage	 Danger Haute Tension	 Peligro alto voltaje
<p>Hazardous voltage can cause electric shock and burns. To avoid shock hazard, disconnect all power to the controller, motor or other control devices before any work is performed on this equipment. Failure to do so will result in personal injury, death or substantial property damage.</p>	<p>Une tension électrique dangereuse peut causer des chocs électriques et des brûlures. Pour éviter des chocs électriques, débrancher l'alimentation du contrôleur, du moteur ou des autres appareils de contrôle avant d'y effectuer du travail. L'inobservation de ces instructions entraînera des blessures corporelles graves, la mort ou des dégâts matériels substantiels.</p>	<p>Voltajes peligrosos que pueden causar descargas eléctricas y quemaduras. Para evitar descargas eléctricas, desconecte la alimentación del controlador, del motor u otros dispositivos de control antes de efectuar cualquier trabajo en el equipo. El incumplimiento de estas medidas ocasionará lesiones personales, la muerte o daños importantes al material.</p>
<p>Do not apply a disconnect device on the output of the <i>IT</i>. Soft Starter unless a means to turn off the soft starter when disconnect switch is open is utilized. Opening disconnect while the <i>IT</i>. Soft Starter is operating may cause a malfunction. Closing disconnect switch while the <i>IT</i>. Soft Starter is operating will result in a soft starter failure and potential equipment damage and personnel hazard.</p>	<p>Ne pas appliquer un appareil de sectionnement sur la sortie du démarreur progressif <i>IT</i>. à moins qu'un moyen d'éteindre le démarreur progressif quand l'interrupteur de sectionnement est ouvert soit utilisé. Le fait d'ouvrir l'interrupteur de sectionnement pendant le fonctionnement du démarreur progressif <i>IT</i>. peut entraîner une défaillance. Le fait d'éteindre l'interrupteur de sectionnement pendant le fonctionnement du démarreur progressif <i>IT</i>. entraînera la défaillance du démarreur progressif et des dégâts à l'équipement ou risque au personnel.</p>	<p>No aplique un dispositivo de desconexión a la salida del arrancador <i>IT</i>. Soft Starter a menos que se utilice un medio para apagar el arrancador cuando el interruptor de desconexión está abierto. La apertura del interruptor de desconexión mientras el arrancador <i>IT</i>. está operando puede ocasionar un funcionamiento incorrecto. El cierre del interruptor de desconexión mientras el arrancador <i>IT</i>. está operando producirá una falla de dicho arrancador, como también potenciales daños a los equipos y riesgo para el personal.</p>

Note: Short circuit protection must be applied on the line side of the soft starter.

The S811 can be wired in both line connected and inside-the-delta connected configurations. If a line configuration is desired then the three-phase line feeding and the three main motor leads should be connected for normal across-the-line starting as shown in **Figure 3-9**. For inside-the-delta connected configurations be sure to consult **Figures 3-10, 3-11 and 3-12**.

Note: Only soft starters with catalog numbers S811xxxxD may be connected in an inside-the-delta configuration. Refer to the motor nameplate for correct wiring information. Contact Eaton if a special motor wiring requirement exists before wiring your starter.

By factory default, the S811 is to be connected with an ABC phase rotation on the incoming power wiring. If the motor turns in the incorrect direction upon energization, exchange two phases at the motor terminal box or at the output terminals of the soft starter. Changing the input wiring will cause a voltage phase reversal trip.

If the input phase sequence to the S811 must be ACB, the incoming phase sequence protection will need to be set to ACB. Setting ACB as the incoming phase sequence causes the ABC incoming phase sequence to cause a voltage phase reversal trip.

IMPORTANT: The reversing contactor must never be switched while the soft starter is operating. In order to gain the full benefit of the S811 with a reversing contactor, the S811 needs to be OFF when switching the direction. The soft starter settings must account for catching a motor spinning in the opposite direction upon soft restarts. The time required for slowing the motor to a stop and then ramping up to speed in the opposite direction adds to the overall starting time. This will also impact the overload protection setting.

See the Motor/Application Considerations in **Appendix E** of this manual for information on typical motor winding configurations.

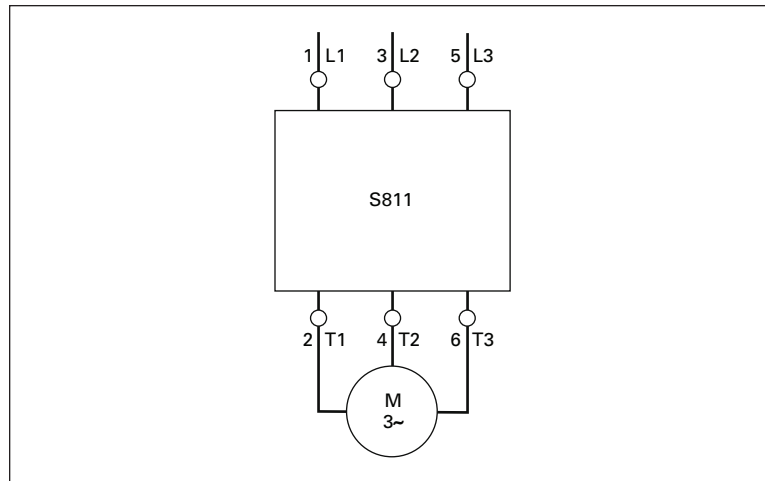

Figure 3-9: Line Connected Soft Starter Power Wiring Diagram

November 2006

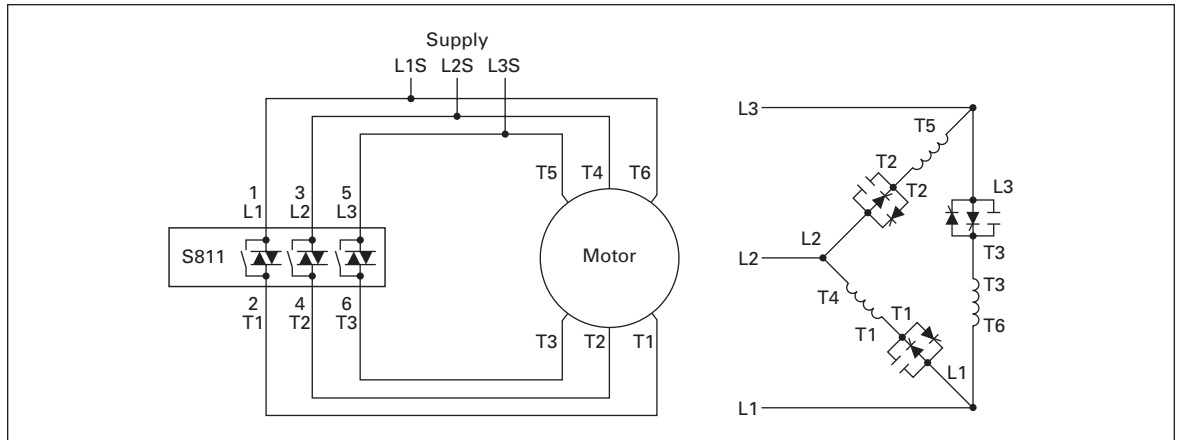

Figure 3-10: Inside-the-Delta Connected Soft Starter Power Wiring Diagram for a 6-Lead Motor

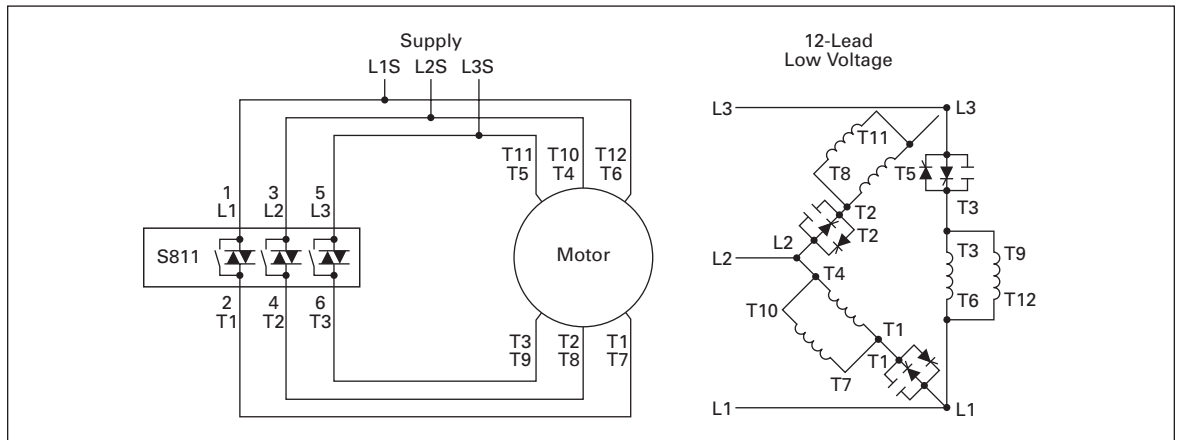

Figure 3-11: Inside-the-Delta Connected Soft Starter Power Wiring Diagram for a 12-Lead Low Voltage Motor

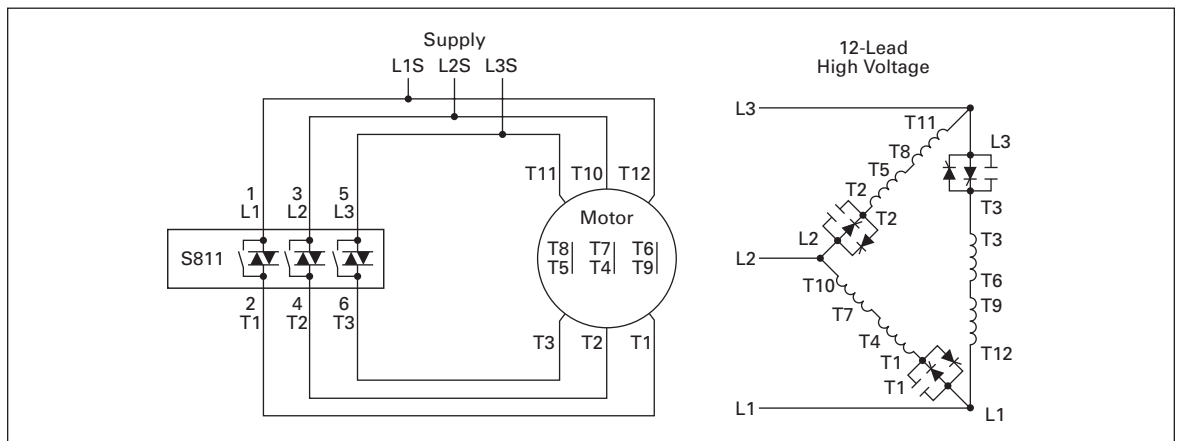

Figure 3-12: Inside-the-Delta Connected Soft Starter Power Wiring Diagram for a 12-Lead High Voltage Motor

Line and Load power wiring data is shown in **Table 3-3**.

Table 3-3: Line and Load Power Wiring

Frame Size	Lug Kit Options	Number of Conductors	Lug Type	Wire Sizes Cu 75°C Only	Torque Requirements	Number of Kits Required
N	Supplied Standard with Box Lugs	1	Box Lug	2 AWG	50 Lb-in (5.6 N•m)	N/A
				4 – 6 AWG	45 Lb-in (5.0 N•m)	
				8 AWG	40 Lb-in (4.5 N•m)	
				10 – 14 AWG	35 Lb-in (4.0 N•m)	
R	Supplied Standard with Box Lugs	1	Box Lug	14 – 8 AWG (2.5 – 10 mm ²)	90 – 100 Lb-in (10.1 – 11.3 N•m)	N/A
				6 – 4 AWG (16 – 25 mm ²)		
				3 – 3/0 AWG (27 – 95 mm ²)		
T & U	EML22	2	—	4 – 1/0 MCM (21.2 – 53.5 mm ²)	250 Lb-in (28.3 N•m)	2
	EML23	1	—	4/0 – 500 MCM (107 – 240 mm ²)	250 Lb-in (28.3 N•m)	
	EML24	2 ^②	—	4/0 – 500 MCM (107 – 240 mm ²)	250 Lb-in (28.3 N•m)	
	EML25	1	—	2/0 – 300 MCM (70 – 150 mm ²)	225 Lb-in (25.5 N•m)	
	EML26	2	—	2/0 – 300 MCM (70 – 150 mm ²)	225 Lb-in (25.5 N•m)	
V	EML28	2 ^②	—	4/0 – 500 MCM (107 – 240 mm ²)	250 Lb-in (28.3 N•m)	2
	EML30	4 ^②	—	4/0 – 500 MCM (107 – 240 mm ²)	250 Lb-in (28.3 N•m)	
	EML32	6 ^{①②}	—	4/0 – 500 MCM (107 – 240 mm ²)	250 Lb-in (28.3 N•m)	
	EML33	4	—	2/0 – 300 MCM (70 – 150 mm ²)	225 Lb-in (25.5 N•m)	

^① Requires special lug cover. Check with Eaton for availability.

^② CSA approved 350 MCM – 500 MCM

November 2006

Lugs for T, U and V Frame

T, U and V frame units are supplied standard without lugs. If lugs are needed, they can be ordered through your local Eaton distributor. Each lug kit contains three lugs, mounting hardware, and instructions for use on either line or load side of the *IT*. Soft Starter. Catalog numbers and wire ranges for lug kits are listed in the table above.

Lug Installation

⚡ Danger High Voltage	⚡ Danger Haute Tension	⚡ Peligro alto voltaje
Hazardous voltage can cause electric shock and burns. Always disconnect power before proceeding with any work on this product.	Une tension électrique dangereuse peut causer des chocs électriques et des brûlures. Il faut toujours débrancher l'alimentation électrique avant de travailler sur ce produit.	Voltajes peligrosos que pueden causar descargas eléctricas y quemaduras. Siempre desconecte la energía eléctrica antes de efectuar cualquier trabajo en el equipo.

Note: For additional motor and system protection, a Metal Oxide Varistor (MOV) may be installed on the line side of the unit. An MOV can also be installed on the load side of the Soft Starter if additional protection is desired. Generally, it is more common to use a MOV on the line side. Refer to the instructions provided with the MOV kit.

1. For T, U and V Frame Soft Starters, remove line and load terminal covers by removing the screws that hold each cover (and the MOV, if installed) onto the unit.

Note: For N and R Frame Soft Starters, it is not necessary to remove the covers in order to wire the device. Proceed to step 3.

2. After screws are removed, slide covers off of unit. Set the covers and screws aside.
3. Position lugs and install lug mounting screws according to instructions provided with the kit. Tighten lug mounting screws provided with the kit to 120 Lb-in (13.6 N•m).
4. Wire the appropriate line and load conductors to the *IT*. Soft Starter (as required by NEC and local codes based on the device rating).
5. Torque bolts as directed by **Table 3-3** on **Page 3-12** of this manual.

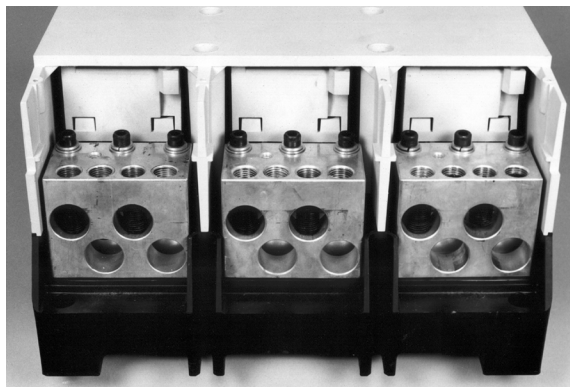

Figure 3-13: V Frame Shown with Terminal Cover Removed and EML30 Lug Kit Installed on Load Side

6. Slide the line and load covers back into place on the soft starter.
7. Reinstall the cover screws through the cover and the MOV, if installed.
8. Insert two outer cover screws through cover.
9. Align cover and torque all cover screws to 5 Lb-in (0.6 N•m). Do not overtighten screws.

Control Wiring Inputs

Control wiring is connected to the S811 by a 12-pin terminal block located at the front of the unit. Using the wiring diagrams in **Figures 3-15, 3-16 and 3-17** and **Tables 3-4 and 3-5** as guides, connect the control wiring as required for your application.



 Caution	 Attention	 Precaución
Only apply 24V DC to the terminal block unless specified otherwise in this manual. All control wiring is 22 – 12 AWG (0.33 – 2.5 mm ²). Failure to follow this caution could result in severe damage to the controller.	Appliquer seulement 24V CC à la barrette à bornes sauf ce manuel offre d’avis contraire. Tout le câblage de commande est de calibre 0,33 – 2,5 mm ² (22 – 12 AWG). L’inobservation de cet énoncé pourrait entraîner des dégâts matériels au contrôleur.	Aplique sólo 24 V CC al bloque de terminales, a menos que se especifique lo contrario en este manual. Todo el cableado de control es de 0.33 – 2.5 mm ² (22 – 12 AWG). Si no respeta esta precaución, se pueden producir daños graves al controlador.



Figure 3-14: Terminal Block

Table 3-4 provides the 12-pin terminal block wiring capacity and torque requirements for the control wiring.

Table 3-4: 12-Pin Terminal Block Wiring Capacity

Wire Size	Number of Conductors	Torque Requirements
22 – 14 AWG (0.33 – 2.5 mm ²)	2	3.5 Lb-in (0.4 N•m)
12 AWG (4.0 mm ²)	1	3.5 Lb-in (0.4 N•m)

November 2006

Input Descriptions

The *IT*. Soft Starter has the following control inputs:

Table 3-5: S811 Terminal Block Control Wiring

Name	Terminal Block Designation (Pin)	Factory Default	Input	Connections
Circuit Common	-	—	Negative	Power supply connections: – Connect power supply negative to pin “-” and to system ground – Connect +24V DC output to pin “+” Note: To avoid voltage drop during bypass contactor inrush, a minimum of 14 AWG wire should be used between the power supply and the “+” and “-” inputs at the S811 terminal block.
Power	+	—	24V DC nominal (see 24V DC Power Supply Requirements section for sizing of power supply)	
Permissive	P	Hardwired STOP	24V DC only (maintained input)	Pin “P”, permissive, must be energized (+24V DC) to enable operation of the unit. If power is removed from the permissive circuit at any time, the unit will begin a STOP command. If a soft stop is selected, the soft stop will begin and run to time-out.
Input 1	1	START	24V DC only (momentary input)	Applying 24V DC to Input 1 while P is energized will initiate a START. As shipped from the factory this input is “level” sensitive.
Input 2	2	JOG	24V DC only (momentary input)	Input 2 is JOG. Applying 24V DC to this input while P is energized will initiate a JOG.
Input 3	3	HAND/AUTO	24V DC only Must be maintained for control from the terminal block	Input 3 is HAND. Energizing this input will select the terminal block as the source of motor control. It must be energized to enable the terminal block to START or JOG the motor.
Input 4	4	Fault RESET	24V DC only	Input 4 is Fault RESET. Energizing this input will reset a fault only after the fault condition has been corrected.
Relay1 Form A NO Contact	13	Common	3 Amps, @ 230V AC/24V DC	NO Form A contact: As shipped from the factory this programmable contact closes when the starter’s bypass contactor is energized. It will remain closed until a STOP is initiated. The motor may continue to run even after the STOP is initiated until the stop ramp has been completed.
	14	NO De-energized		
Form C Common	95	Common	Form C Common for 96 and 98	Form C contacts: As shipped from the factory these programmable contacts will change status when a Fault occurs.
Relay2 Form C NC Contact	96	NC De-energized	3 Amps, @ 230V AC/24V DC	
Relay2 Form C NO Contact	98	NO De-energized	3 Amps, @ 230V AC/24V DC	

Typical Control Wiring Diagrams

Each diagram illustrates a typical wiring scheme for the options described. The terminal block represents the soft starter. The additional Cutler-Hammer items shown on the diagrams are not included, but they may be purchased from Eaton.

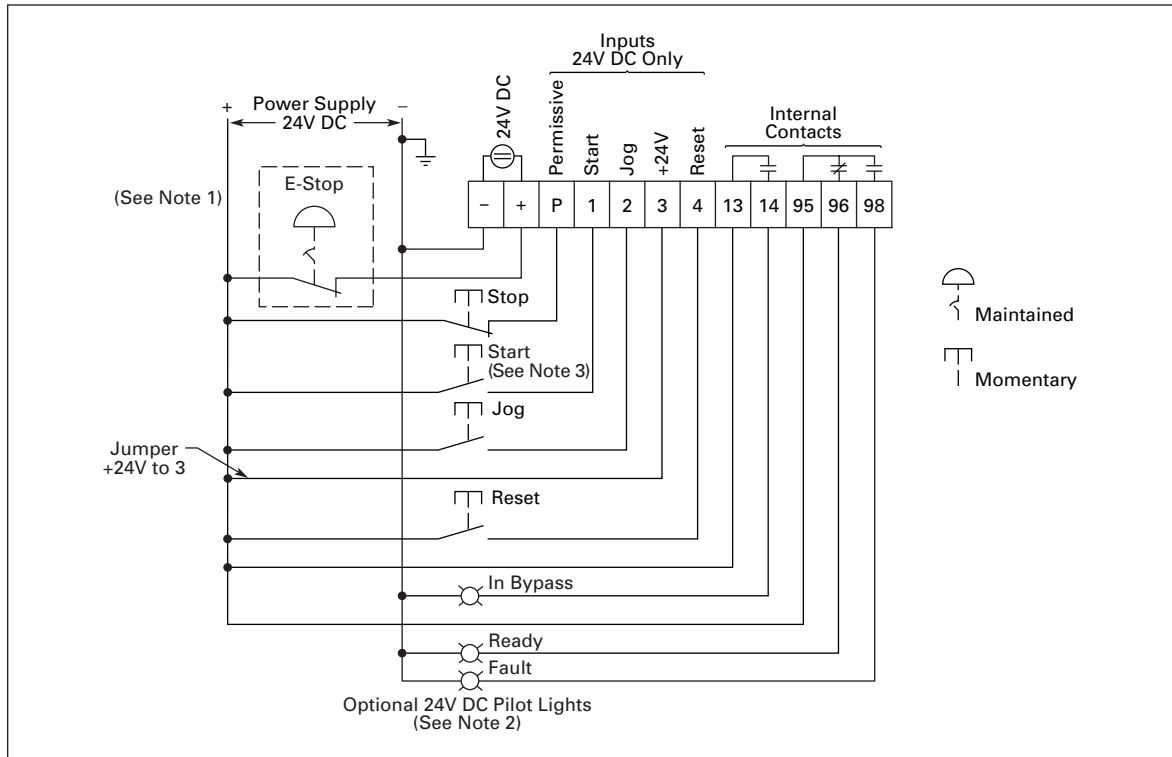

Figure 3-15: Basic Connection Diagram for 24V DC 3-Wire Pushbutton STOP/START/JOG/RESET and 24V DC Fault/Ready and Bypass Indication

November 2006

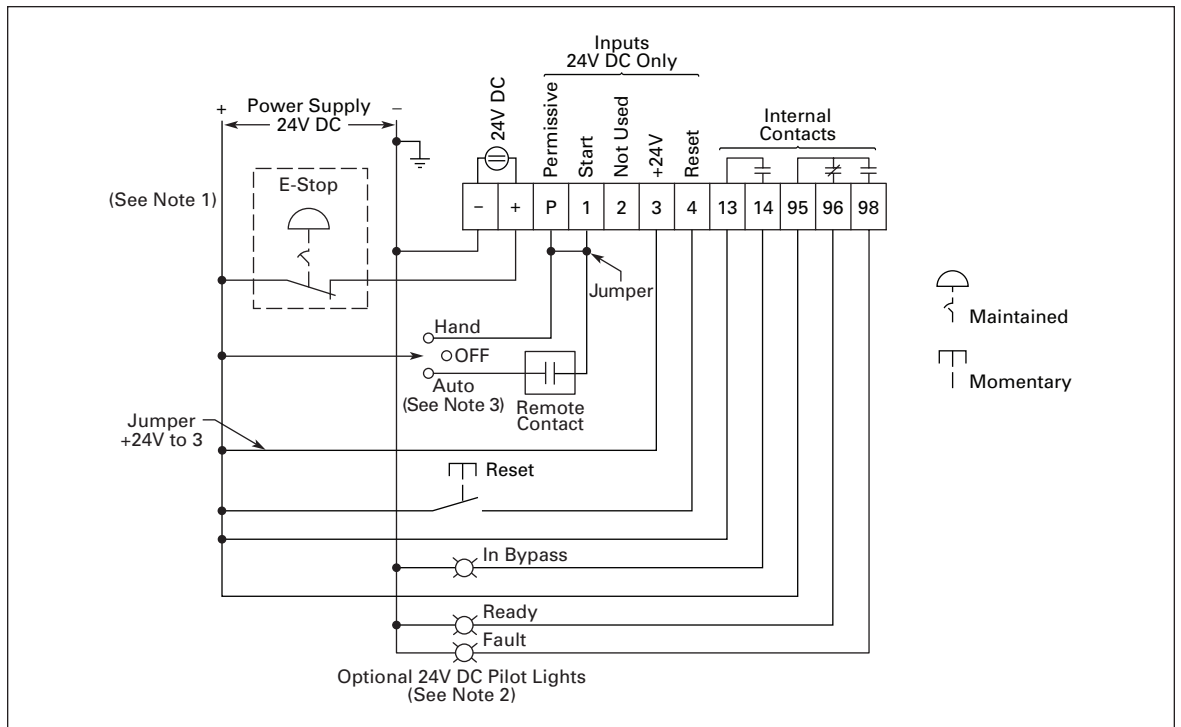

Figure 3-16: Basic Connection Diagram for 24V DC 2-Wire Switch HAND/OFF/AUTO/RESET and 24V DC Fault/Ready and Bypass Indication

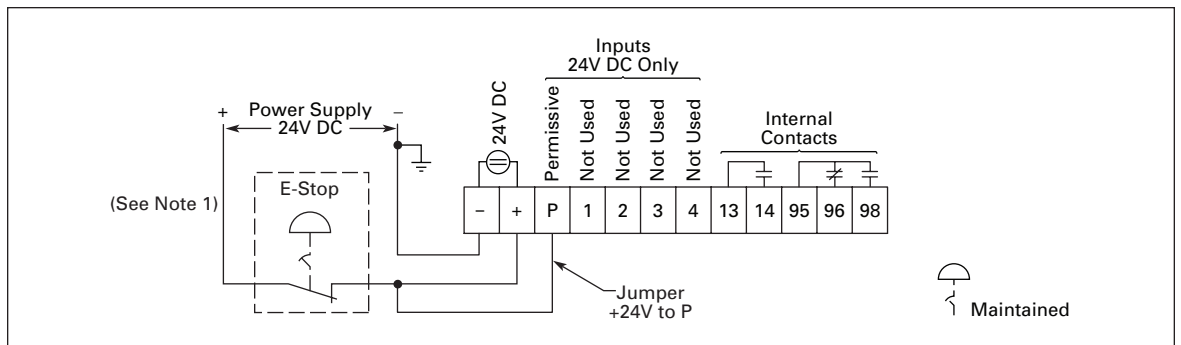

Figure 3-17: Basic Connection Diagram for Use of DIM Control Only

Notes:

1. A minimum wire of 14 AWG (2.5 mm²) should be used between the power supply and the 24V DC + and - terminals.
2. See Using an Auxiliary Relay section below if it is desired to use a relay instead of an indicating lamp for terminals 13, 14, 95, 96 and 98.
3. If an isolation or reversing contactor is used upstream of the S811, Eaton recommends that the user choose the level sensing option.

Each diagram illustrates a typical wiring scheme for the options described. The terminal block represents the soft starter. The additional Cutler-Hammer items shown on the diagrams are not included, but can be purchased from Eaton.

24V DC Control Power Supply

The S811 Soft Starter requires 24V DC control power. The sealed in and inrush characteristics of the S811 Soft Starter are summarized in **Table 3-6**:

Table 3-6: 24V DC Power Supply Requirements

Soft Starter Frame	Sealed		Inrush		
	Watts	Amps	Watts	Amps	Duration (ms)
S811N	25	1.0	240	10	150
S811R	25	1.0	240	10	150
S811T	25	1.0	240	10	150
S811U	25	1.0	240	10	150
S811V	25	1.4	240	10	150

For applications where one starter is used with one power supply, the power supply selected must be equal to or greater than both the sealed in and inrush requirements of the starter.

- Max Steady State for the Power Supply ≥ Sealed In Power of the Starter
- Outrush for the Power Supply ≥ Inrush Power of the Starter

Multiple starters can be used with one power supply. If the application requires the starters to start at the same time, the power supply must be sized for the sum of the sealed in and inrush power for each starter.

- Max Steady State for the Power Supply ≥ Sum of the Sealed In Power of all the Starters
- Outrush for the Power Supply ≥ Sum of the Inrush Power of all the Starters

Multiple starters are typically not commanded to start at the same time. If the application requires the starters not be commanded to start at the same time (>150 ms between start commands), the required power is the sum of the largest inrush power, plus the sealed in power of the running starters. Worst case from a power supply standpoint is the largest inrush starter commanded to start while all the other starters are running.

November 2006

Formulas to calculate power supply requirements are as follows:

- Definitions:
 SI = Sum of Seal Incurrent
 LS = Largest Seal Incurrent
 LI = Largest Inrush Needed
 TS = Total Seal Incurrent Needed
 LO = Largest Outrush Needed



 TS = (SI - LS)
 LO = TS + LI
- Max Steady State for the Power Supply \geq SI
- Outrush for the Power Supply \geq LO

The voltage on the S811 + and – control terminals must not exceed 30V DC to prevent hardware damage. The S811 will shut down and issue low control voltage fault at control voltages less than 17V DC. The fault will reset at control voltages greater than 18V DC. The Cutler-Hammer control power supplies listed in **Table 3-7** are recommended.

Table 3-7: 24V DC Power Supplies

Catalog Number	Continuous		Peak	Input Voltage VAC
	Watts	Amps	Amps	
PSS55A	55	2.3	10.0	90 – 140
PSS55B	55	2.3	10.0	180 – 260
PSS55C	55	2.3	10.0	360 – 500
PSS160E	160	6.5	13.0	90 – 260
PSS160C	160	6.5	13.0	360 – 500
PSS300E	300	12.5	20.0	90 – 260
PSS600C	600	25.0	50.0	360 – 500

Control Wiring Application Notes

 Caution	 Attention	 Precaución
Only apply 24V DC to the terminal block unless specified otherwise in this manual. All control wiring is 22 – 12 AWG (0.33 – 2.5 mm ²). Failure to follow this caution could result in severe damage to the controller.	Appliquer seulement 24V CC à la barrette à bornes sauf ce manuel offre d’avis contraire. Tout le câblage de commande est de calibre 0,33 – 2,5 mm ² (22 – 12 AWG). L’inobservation de cet énoncé pourrait entraîner des dégâts matériels au contrôleur.	Aplique sólo 24 V CC al bloque de terminales, a menos que se especifique lo contrario en este manual. Todo el cableado de control es de 0.33 – 2.5 mm ² (22 – 12 AWG). Si no respeta esta precaución, se pueden producir daños graves al controlador.

1. Connect DC common (negative) to terminal -, using a minimum wire of 14 AWG (2.5 mm²).
2. Connect +24V DC positive to terminal +, using a minimum wire of 14 AWG (2.5 mm²).
3. Terminal P (permissive circuit) — Must be energized at +24V DC to enable operation of all S811 soft starters. For all units, if power is removed from the permissive circuit at any time, the unit will initiate a stop sequence, including a soft-stop if enabled.

Note: With level sensing control, if +24V DC is removed from the permissive circuit at any time, the unit will initiate a stop and restart when +24V DC is reapplied to terminal P if:

- a) +24V DC is still available on pin 1 (to start from Terminal Block, Input #3 must also be enabled),
- b) the device shows a green status light (not faulted). If the starter has faulted and the fault condition clears then if the *Reset Mode* parameter is set to AUTO on Digital Interface Module (DIM), the starter will restart.

See the Edge and Level Sensing sections below for more details. **If the AUTO Reset Mode setting is used, CAUTION must be exercised to assure that any restart occurs in a safe manner.**

4. Terminal 1 (Start mode) — If terminal P is at +24V DC, momentary application of +24V DC to terminal 1 will initiate a start sequence for all S811 soft starters.

Edge Sensing

Edge sensing is set with the *Start Control* parameter.

Edge sensing requires +24V DC power be momentarily applied to pin 1 (with terminal P at +24V DC) to initiate a start under all conditions. After a stop or fault occurs, the +24V DC must be removed, then reapplied to pin 1 before another start can occur. This control configuration should be used when restarting of the motor after a fault or stop must be supervised manually or as a part of a control scheme. The cycling of +24V DC power to terminal 1 before starting is required regardless of the setting of the *Reset Mode* parameter.

Level Sensing

Level sensing is set with the *Start Control* parameter.

Level sensing will enable a motor to restart after a fault is cleared without cycling +24V DC power to terminal 1 as long as:

- Terminal P is supplied with +24V DC (to start from Terminal Block, Input #3 must also be enabled),
- The *Reset Mode* parameter is set to AUTO,
- All faults have been reset.

This control configuration should be used where it is desirable to restart a motor after a fault without additional manual or automatic control. An example of this condition would be on a remote pumping station where it is desirable to automatically restart a pump after a power outage without operator intervention.

In the AUTO RESET MODE, CAUTION must be exercised to assure that any restart occurs in a safe manner.

November 2006

5. Terminal 2 (Jog mode) — If +24V DC power is applied to this terminal while terminal P is at +24V DC, the soft starter will operate in the jog mode as long as +24V DC is on terminal 2 and no faults occur. In jog mode, the soft starter will operate only on the thyristors and the bypass contactors will not close.
6. Terminal 3 (HAND/AUTO setting) — Input 3 selects the terminal block as a source of motor control. It must be energized to enable the terminal block to START or JOG the motor.
7. Terminal 4 (Reset) — Application of +24V DC power will reset the soft starter after all fault conditions are cleared. **If the AUTO Reset Mode setting is used with level control CAUTION must be exercised to assure that any restart occurs in a safe manner.** See Edge and Level sensing on **Page 3-20**.
8. Terminals 13 and 14 (Programmable) — At default setting, relay contacts for use up to 230V AC or 24V DC provide bypass contactor status. The contact closes upon bypass and will remain closed until a stop is initiated or a fault occurs. The motor and load may continue to rotate after a stop is initiated if soft stop is being used or if the load inertia is high. See Using an Auxiliary Relay section below for additional contact interface information.
9. Terminals 95, 96 and 98 (Programmable) — At default setting, relay contacts for use up to 230V AC or 24V DC provide fault or ready status indication. See **Page 3-15** for a description of their operation.

Connecting a New or Replacement DIM

When 24V DC is first applied to terminals + and -, the S811 will send commands to the DIM to reconfigure its communication, and the S811 will send a reset to the DIM after configuration is done (this process takes approximately 20 seconds).

Using an Auxiliary Relay

The *IT*. Soft Starter contains one Form A and one Form C set of auxiliary contacts to indicate its status. A contact between terminals 13 and 14 indicates when the *IT*. is in bypass (unless it has been programmed to indicate another status). The contacts between terminals 95 and 96 and 95 and 98 indicate the *IT*. is in a normal or tripped state (unless it has been programmed to indicate another status). Often these contacts are used as shown in **Figures 3-15, 3-16 and 3-17** with indicating lamps. In some installations the user may wish to use an electromagnetic relay for indication of the status at a remote location for use by a programmable controller (PLC), or in a 230V AC or 24V DC control circuit.

If the *IT*. Soft Starter is subject to mechanical shock during operation, it is possible that these contacts may momentarily open, causing nuisance fault tripping of down stream devices. When used with an indicating lamp, a momentary contact opening would not be observed. In order to assure proper application, it is suggested that the following recommendations be followed:

PLC Interface — It is suggested that a 20 mS delay be programmed to assure the contact status before a change of status is indicated. The application and the environmental issues will determine the exact requirements.

24V DC Control — When a relay is used in conjunction with an electronic control, it is highly recommended that a noise suppression/snubber diode be placed across the relay coil as shown in **Figure 3-18**. This diode offers two benefits. First, the suppression of any electrical noise generated when the relay coil is de-energized. Second, the diode delays the opening of the relay slightly as it dissipates the energy stored in the relay coil. This delay is often long enough to compensate for the potential effects of a mechanical shock opening the control contact. A typical suppression diode is a 1N4001.

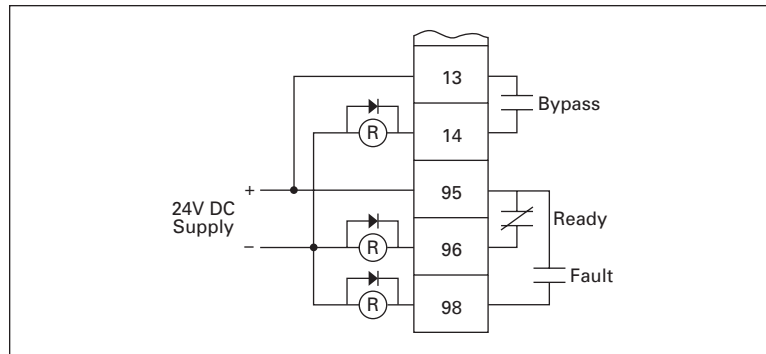

Figure 3-18: 24V DC Control

120V AC Control — When a relay is used in conjunction with an electronic control, it is highly recommended that a noise suppressor be used across the relay coil. In the case of an AC coil, the noise suppressor is made up of a series connected resistor and capacitor as shown in **Figure 3-19**. Usually the delay in the relay opening is very small, so if the system is subject to shock, a delay should be added in the external control before the contact change of state is recognized. The resistor is rated 100 ohms at 0.5 watts. The capacitor is 0.25 μ F at 250V AC.

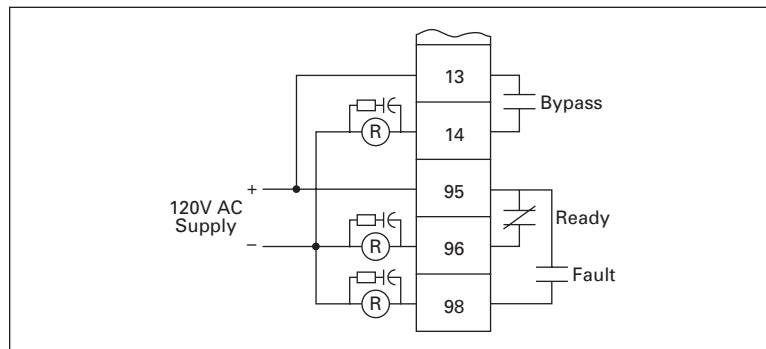

Figure 3-19: 120V AC Control

Using a Supplemental Line Contactor

In some installations, it may be necessary to use an electromagnetic contactor in series with the soft starter. In this case, it is recommended that the contactor be placed on the load side of the soft starter. The contactor must be closed prior to starting the soft starter and remain closed until the Soft Starter has been stopped to ensure proper soft starter and system operation.

November 2006

If an electromagnetic contactor is used on the line side of the soft starter, additional control circuitry must be supplied by the user when using edge control to ensure the line power is supplied to the soft starter before control power (24V DC) is applied. If this sequence is not followed, the soft starter will fault on either a phase loss or zero voltage-crossing fault. This control scheme is illustrated in **Figure 3-20**.

If it is desired to place an electromagnetic contactor on the line side of the soft starter, when using level control, no additional control circuitry is required. A start can be completed when the line power is supplied to the unit after the control power (24V DC), providing the *Reset Mode* parameter is set to AUTO and the unit has a green light status with +24V DC on pin 1.

If the AUTO Reset Mode setting is used, CAUTION must be exercised to assure that any restart occurs in the safe manner.

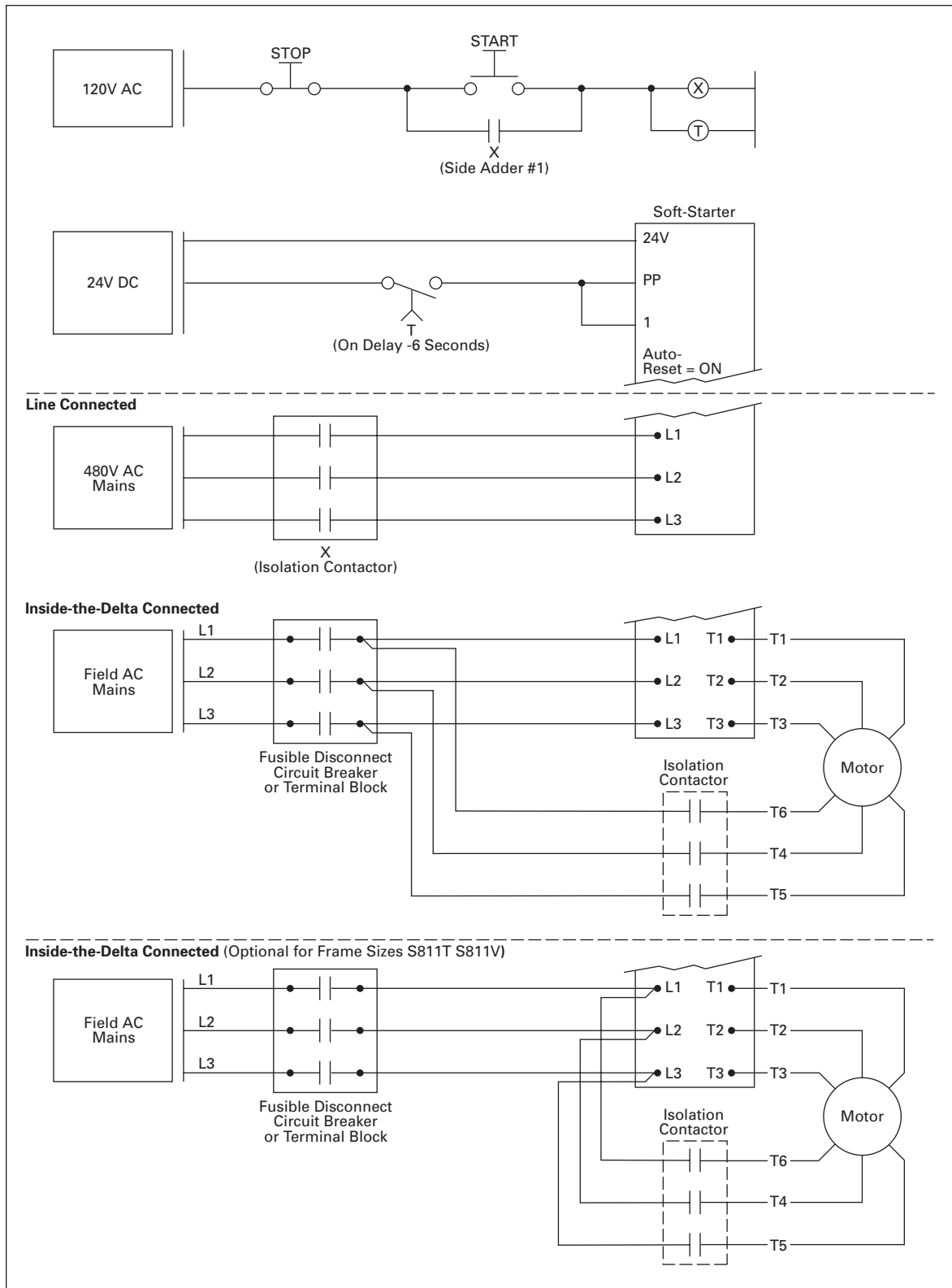

Figure 3-20: 24V DC Control with Edge Sensing

November 2006

Chapter 4 — Specifications

Environmental

Table 4-1: Environmental Specifications

Item	Specification
Temperature Range — Operating Storage	-40°F – 122°F (-40°C – 50°C) -58°F – 158°F (-50°C – 70°C)
Elevation	Up to 6,600 ft. (2000m). Above 6,600 ft. (2000m), derate 0.5% per 330 ft. (100m)
Humidity	Functional to 95% non-condensing
Operating Orientation	Any
Pollution Degree IEC 60947-1	3
Shock Resistance	15g in any direction
Vibration Resistance	3g in any direction

Physical

Table 4-2: Weight

Frame Size	Weight of Unit
N	5.8 Lbs. (2.6 Kg)
R	10.5 Lbs. (4.8 Kg)
T & U	48 Lbs. (21.8 Kg) with lugs
	41 Lbs. (18.6 Kg) without lugs
V	103 Lbs. (46.8 Kg) with lugs
	91 Lbs. (41.4 Kg) without lugs

Table 4-3: Agency Standards and Certifications

Standard	Certifications
UL	UL 508
CSA	CSA 22.2 – 14 – 1995
IEC	60947-4-2
CE	See Table 4-4

CE Conformance

Table 4-4: EMC Immunity

Immunity	Severity Level
Electrostatic Discharge IEC 61000-4-2	4 kV contact discharge 8 kV air discharge
Electromagnetic Field IEC 61000-4-3	10 V/m 80 – 1000 MHz 2 angles
Fast Transient Bursts IEC 61000-4-4	2 kV, 5 kHz rep, 2 min intervals
1.2/50 μ S – 8/20 μ S Surges IEC 61000-4-5	2 kV Line to earth 1 kV Line to Line 1 minute intervals
Conducted RF IEC 61000-4-6	10 V rms .15 – 80 MHz
50 Hz Magnetic Field IEC 61000-4-8	N/A
Voltage dips Interrupt IEC 61000-4-11	30% dip @10 mS 60% dip @100 mS 100% interrupt @5 S

Emissions

Radiated	EN 55011, Class A
Conducted	EN 55011, Class A

1. The 24V DC power supply must be grounded.
2. Add ferrite, Fair-Rite #0444173551 to DC Power Leads and Control I/O Leads (all through one ferrite) at S811 with two passes through ferrite of the DC Power Leads, and a single pass through ferrite of the I/O Control Leads.
3. Add ferrite, Fair-Rite #0443167251 to Load Leads at S811 with two passes through ferrite.

November 2006

Short Circuit Ratings

Table 4-5: Short Circuit Ratings

Soft Starter Frame Size	Three-Phase Short Circuit Rating			
	240V	480V	600V	690V
N	10 kA	10 kA	10 kA	—
R	10 kA	10 kA	10 kA	—
T	18 kA	18 kA	18 kA	① ③
U	30 kA	30 kA	30 kA	—
V	42 kA	42 kA	42 kA	② ④

① Catalog No. S811T__V3S devices are UL Listed and suitable for use on a circuit capable of delivering not more than 18 kA symmetrical amperes, 690 volts maximum, when protected by a Ferraz-Shawmut Amp-Trap Form 101 (Cat. No. A70QS800-4) 800 Amp, 700 Volt Semiconductor Protection Fuse.

② Catalog No. S811V__V3S devices are UL Listed and suitable for use on a circuit capable of delivering not more than 42 kA 690 volts maximum, when protected by a Ferraz-Shawmut Type PSC (Cat. No. A070URD7311600) 1600 Amp, 700 Volt Semiconductor Protection Fuse.

③ Catalog No. S811T__V3S devices tested per IEC 60947-4-2 to Type 1 Short Circuit Withstand Requirements to 18 kA, 690 volts with Cutler-Hammer Cat. No. NW3800T33W 800 Amp 690 Volt circuit breaker.

④ Catalog No. S811V__V3S devices tested per IEC 60947-4-2 to Type 1 Short Circuit Withstand Requirements to 42 kA, 690 volts with Cutler-Hammer Cat. No. RW420T33W 2 kA 690 Volt circuit breaker.

Note: Short circuit protection must be applied on the line side of the soft starter.

November 2006

Chapter 5 — Functional Description

Power

The S811 Soft Starter controls the voltage applied to a three-phase induction motor in order to control the starting torque and provide a smooth starting characteristic. Within the soft starter are three power poles, each of which includes a set of anti-parallel SCRs (thyristors) in parallel with a contact. During a start, the conduction periods of the SCRs are continuously adjusted to apply a gradually increasing voltage to the motor, resulting in gradually increasing torque and a smooth start. As the motor reaches its rated speed, the power pole contacts are closed, bypassing the SCRs for the most efficient operation.

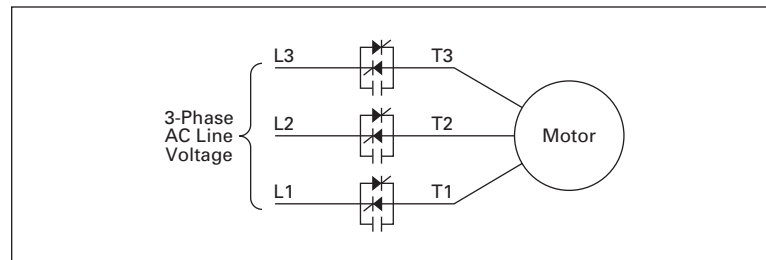

Figure 5-1: Line Connected Soft Starter SCRs

For each start, the length of time the SCRs are conducting current as well as the magnitude of that current determine how hot the SCRs will get. Between successive starts the SCRs must cool down to avoid exceeding their thermal limits. **Appendices C** and **D** (Ratings, Cooling and Power Losses) gives the S811's application ratings for various starting conditions. Staying within these specified limits should avoid over temperature trips.

When the S811 control circuit senses that the internal temperature has increased above a preset value, internal fans are tuned on to assist in cooling. To maximize fan life the fans are only turned on when needed. Further discussion of fan operation can be found in **Appendices C** and **D**.

Control

The software contained in the S811 *IT*. Soft Starter is the heart of the product. This software allows you to control nearly every aspect of the soft starter's functionality. In this section, various features and protection options are described.

Note: In the following descriptions the S811 Parameter Names are shown in *italics*. You will find a complete listing of these parameters in **Appendix A**.

Note that the motor current measurements made with a standard meter may not be correct because of the non-sinusoidal nature of the current during starting. The S811 is designed to accurately measure these currents so that the current displayed by the S811's Digital Interface Module (DIM) is correct.

Starting Options

The following starting choices are available in the S811 *IT*. Soft Starter:

Voltage Ramp Start

This is the most commonly used mode of soft starting. Starting at an initial value set by the *Initial Torque* parameter, the voltage applied to the motor is gradually increased at a rate that will reach rated voltage at time t_r , set by the *Soft Start Time* parameter. As the voltage increases the motor develops torque that accelerates the load toward full speed. When the S811 senses that the motor has come up to speed, it quickly completes the voltage ramp and closes the bypass contactor. See **Figure 5-2**.

It should be noted that a lightly loaded motor takes less torque, and thus lower voltage and time, to accelerate to full speed. For this case the S811 will go into bypass before the ramp reaches full voltage. In other words, the S811 will go into bypass before the *Soft Start Time* has elapsed.

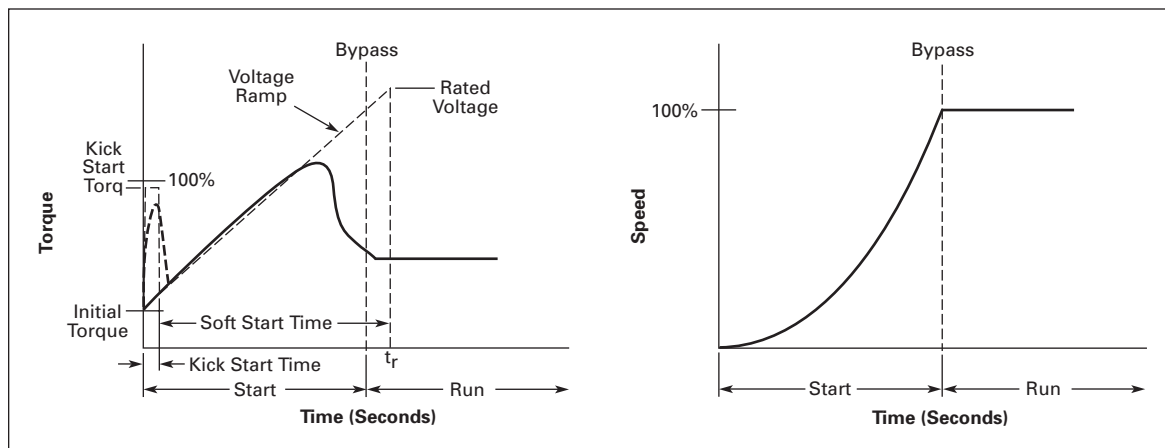

Figure 5-2: Ramp Start

Kick Start — The Kick Start feature works in both the Voltage Ramp Start and Current Limit Start modes. By momentarily applying a pulse of current to the motor, it provides an initial boost in torque to overcome the static friction common in some applications. The level of torque boost is set by the *Kick Start Torq* parameter and the duration of the “kick” is set by the *Kick Start Time*. Setting the *Kick Start Time* to 0 disables this feature.

November 2006

Current Limit Start

This mode is typically used when it is necessary to limit the maximum current during start-up due to line power limitations or other considerations. During a Current Limit Start the S811 applies a constant voltage to the motor, resulting in limited current flowing through the motor’s windings. The level of current is set by the *Initial Torque* parameter. See **Figure 5-3**.

Note: Current Limit Starts are not recommended on variable torque load applications like fans and pumps.

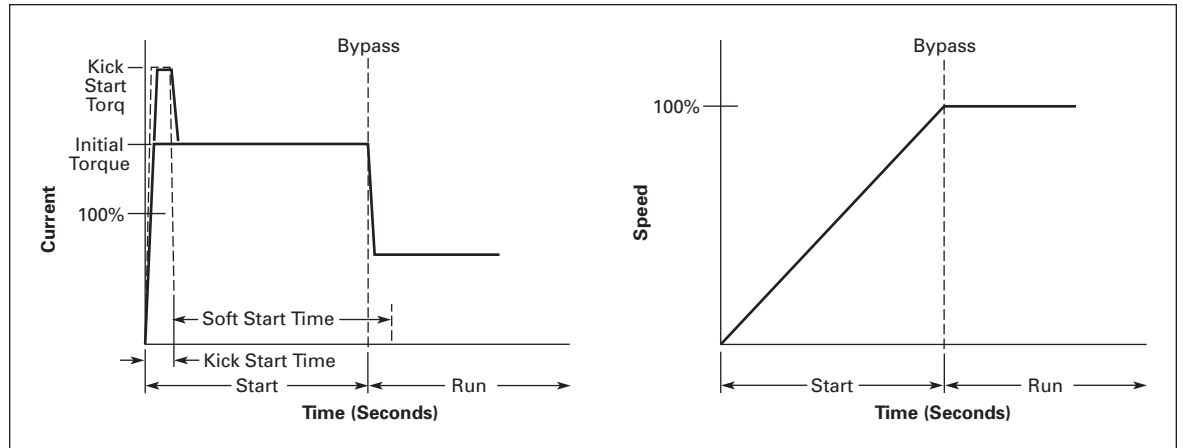

Figure 5-3: Current Limit Start

Soft Stop — This feature is used for applications that require a controlled extended stop. It is designed for high frictional loads that tend to stop suddenly when voltage to the motor is removed. During Soft Stop the voltage is gradually reduced to zero in the time set by the *Soft Stop Time* parameter. See **Figure 5-4**.

Note: The Soft Stop mode is not an electronic brake function and will not stop a motor any faster than it would normally take to coast to a stop under load.

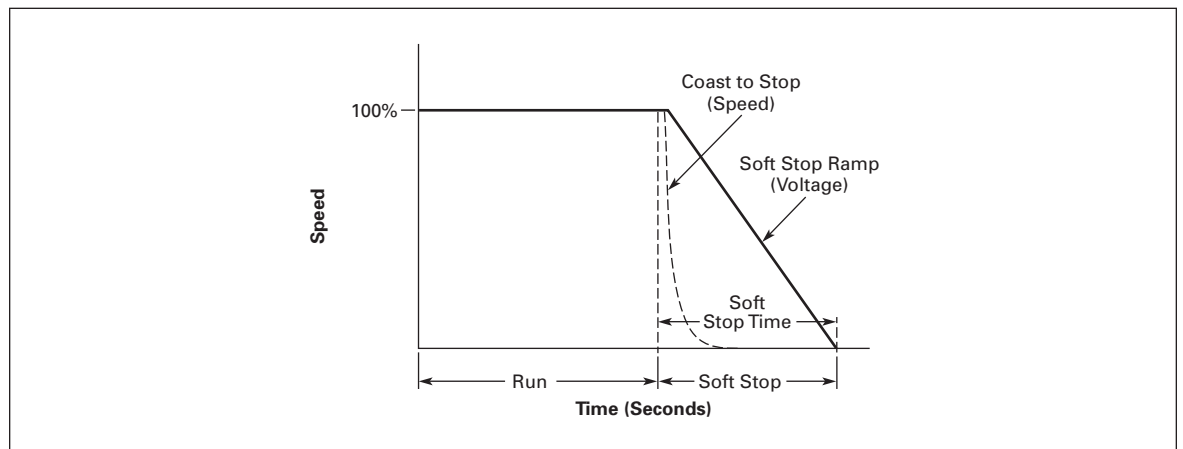

Figure 5-4: Soft Stop

Pump Start/Stop (Optional) — This pump control option is described in **Appendix F**.

Protection

Thermal Overload

The **IT. S811** Soft Starter features an electronic motor overload protection feature. It is designed to protect the motor and power wiring against overheating caused by operating at excessive current levels for extended periods of time.

Entering the motor's full load current rating, using the *Overld Trip FLA* parameter programs the overload. The *Overld Trip FLA* is settable from 32% to 100% of the S811's rated current.

The overload's trip class is set using the *Ovrlld Trip Class* parameter.

Additional details on the Thermal Overload can be found in **Appendix B**.

S811 and Motor Protection

In addition to motor overload protection, the S811 has many programmable features designed to protect the motor as well as the soft starter itself.

- Incoming Line Phase Reversal, Loss, Imbalance, Over Voltage, and Under Voltage trips
- Three Overcurrent trips
- Stall and Jam trips

For troubleshooting purpose trips are recorded, as they occur, in the S811's Device Status, Fault List and Fault Queue.

QCPort Network Control

The S811 has two QCPort communications ports, Local (CH1) and Remote Network (CH0).

Local Control (HAND)

S811 Local Control usually consists of the terminal block and one DIM connected to the Local Port (CH1). Additional DIMs, QCPort Cover Controls, as well as other QCPort devices can be connected to the Local Port and used as input devices to control the operation of the S811. Each device sends a Motor Control byte to the S811 which logically combines them and responds appropriately.

Remote Network (AUTO)

The S811 will switch to AUTO control whenever all local control devices have released (de-energized) their LOCAL control signal. When the S811 is in AUTO control it is ready to respond to motor control commands issued through the Remote Network (CH0). Typically an industrial automation fieldbus is connected to the Remote Network port via one of the many network adapters (gateways) available from Eaton.

For further discussion of the network ports, refer to **Appendix H**.

November 2006

Chapter 6 — Configuration

Programming the S811

A Digital Interface Module (DIM) is used to configure all models of the *IT*. S811 Soft Starter.

- The Status Bar at the top of the display indicates the operating and communicating status of the S811 and DIM.
- The three Soft Key Functions at the bottom of the display indicate the functions of the Soft Keys (pushbuttons) directly below them. The Soft Key Functions will change as you navigate through the different menus of the DIM.
- The center of the display shows the value of the selected S811 parameter. The default display at power-up is “3 ∅ Line Currents”.
- **Figure 6-1** shows how the S811’s parameters are organized within the menu structure. Navigating through the menus down to the parameters is straightforward if you understand a few basic concepts.
 1. The Escape Key (ESC) moves you from the User Display to the Parameter Edit Screen.
 2. The PREV and NEXT soft keys (**Figure 6-2**) scroll from menu to menu (left and right).
 3. The far right soft key will allow you to take action (Enter, Edit, More, Send, ...) to “drill down” into the menu or parameter.
 4. When you enter a menu, the Previous and Next soft keys scroll from parameter to parameter (up and down) in that menu.
 5. The Escape Key backs you out of the current parameter or menu.

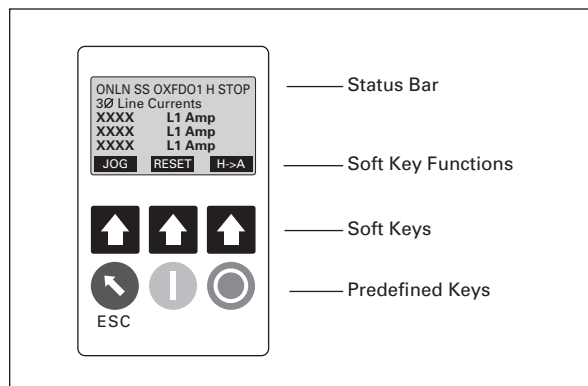

Figure 6-1: Digital Interface Module (DIM) — Display Mode

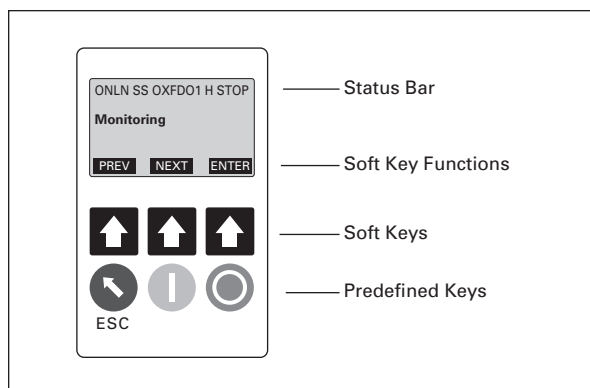

Figure 6-2: Digital Interface Module (DIM) — Parameter Edit Mode

For a more complete description of the DIM, refer to **Appendix G**.

S801 to S811 Comparison

If you are familiar with the adjustments of the S801 Soft Starter, **Table 6-1** provides you with a cross-reference between the CIM potentiometer and switch adjustments and the corresponding S811 parameters found in the Configuration and Protection menus of the S811’s Digital Interface Module (DIM).

Table 6-1: S801 to S811 Setup Cross-Reference

Description	S801 CIM	S811 DIM Parameter	Units	Comment
Configuration Menu				
Overload setting	FLA	<i>Overld Trip FLA</i>	Amps	Set for motor’s nameplate rated current assuming a 1.15 Service Factor motor. See Appendix C for other Service Factor motors.
OL Trip Class	Trip Class	<i>OvrlD Trip Class</i>		5, 10, 20 and 30
Kick Start Torque	T1	<i>Kick Start Torq</i>	% rated torque	Sets the initial breakaway torque to overcome static friction loads.
Kick Start Time	tk	<i>Kick Start Time</i>	Sec	Sets the duration of the Kick Start
Initial Voltage Ramp Torque	T2	<i>Initial Torque</i>	% rated pull-out torque	Sets the initial voltage (torque) of the Voltage Ramp Start.
Current Limit Torque	T2	<i>Initial Torque</i>	% rated pull-out current	Sets the constant current (torque) applied to the motor throughout its acceleration to full speed.
Voltage Start Ramp Time	tr	<i>Soft Start Time</i>	Sec	Sets the time to ramp up to rated voltage (torque). If the motor is not up to speed at the end of the ramp, the S811 will trip on a Stall Fault. Note: Lightly loaded motors will reach full speed, and the bypass contactor will close, before tr elapses.

November 2006

Table 6-1: S801 to S811 Setup Cross-Reference, continued

Description	S801 CIM	S811 DIM Parameter	Units	Comment
Configuration Menu, continued				
Current Limit Start Time	tr	<i>Soft Start Time</i>	Sec	Sets the time at which the S811 expects the motor to be up to speed. When tr elapses the S811 checks for a stall condition.
Stop Ramp Time	ts	<i>Soft Stop Time</i>	Sec	Sets the time to linearly ramp down from rated voltage to zero. The rate at which the motor slows is dependent on the load. Not functional on S811s with Pump Option if start method is Pump Start.
Pump Stop Time (option)	ts	<i>Pump Stop Time</i>	Sec	Sets the time to ramp down the speed of the motor to zero. Not functional on standard S811s. S811s purchased with the pump stop option must set the DIM <i>Start Method</i> to Pump Start to activate the Pump Stop option.
Protections Menu				
Overload	Overload	<i>Ovld Fault</i>		
Jam	Jam	<i>Jam Fault</i>		
Stall	Stall	<i>Stall Fault</i>		
Phase Loss	Ph. Loss	<i>Phase Loss Fault</i>		
Phase Imbalance	—	<i>Phase Imb Fault</i>		
Phase Sequence Reversal	Ph. Rev	<i>Phase Rev Fault</i>		See also <i>Phase Sequence</i>
Fault Reset	Man/Auto Reset	<i>Reset Mode</i>		
Special Function				
Ramp / Current Limit Start	Ramp Start	<i>Start Method</i>		
Option — Configuration Menu				
Option		S811 DIM parameter	Default	
Edge/Level Start Input		<i>Start Control</i>	Level	Sets whether the Start input at the terminal block responds only when it sees a transition from 0 to +24V DC (edge) or anytime 24V DC is present (level)

November 2006

Chapter 7 — Setup and Starting

Before You Begin

Be Aware of the Following:

1. Terminal P must have 24V DC applied to ENABLE starts.
2. The P and Hand inputs must be energized (24V DC) to enable starting of the Soft Starter from the terminal block.
3. To Start: Apply 24V DC to Input 1 while the P input is energized.
4. To initiate a Stop remove the P input.
5. For 2-wire control, jumper P and Input 1 together.
6. After an Overload Trip, the S811 Soft Starter cannot be restarted until the prescribed cool-down time has elapsed. Cycling power does not reset the timer. If 24V DC power is removed, the soft starter will remember the remaining time and will resume the cool-down timing when power is again reapplied.
7. On frames R, T, U and V when the S811 goes into bypass, a sound similar to contactor chatter can be heard. This sound is the result of multiple contactors closing one after the other in a very short period. It is normal operation intended to reduce the surge current requirements of your power supply.
8. To Jog: apply 24V DC to input 2, (terminal P must also have 24V applied). To stop remove 24V DC from input 2.
9. In jog, the unit will follow the normal start ramp as long as terminal 2 is at 24V DC.
10. Jog operates the same as a normal start, except that the bypass contactors will not close and the soft stop is not functional.
11. Jog is only intended for short term jogging of the motor and not for long term two-wire control.

Setup

After all power and control connections have been made and you have read and understood the different operating modes and protection features (**Chapter 5**) of the soft starter, it is time to program it for your application. The following procedure will take you through the setup of the S811 to match it to your motor and application, “bumping” the motor to verify correct direction of rotation, and tuning of the selected operating mode. After this procedure has been completed, it is suggested that you review the Protection Options of the S811 (**Appendix B**) and select the appropriate ones for your application. All Protection Options are shipped from the factory “enabled”.

As shipped from the factory, the S811 Soft Starter’s default configuration is sufficient for basic operation but may require some configuration to “tune” it for your application. The following procedure assumes you understand how to “navigate” through the S811’s parameter menu using the Digital Interface Module (DIM) and that the S811 is in its Factory (Out-of-Box) state. Refer to **Appendix G** of this manual for a detailed explanation of DIM operation.

Initial Configuration:

1. It is suggested that the S811 Soft Starter be configured before applying the line voltage. Before applying the Line voltage, apply 24V DC to the + and - connections of the S811's terminal block. "Eaton Cutler-Hammer" will be displayed by the DIM while the S811 is powering up. When power-up is complete the DIM should be displaying "3 Ø Line Currents".

Note: If anything else is displayed, go to **Chapter 8**, Troubleshooting, for information on getting the S811 back to a known state.

2. Using the DIM, review the parameter settings in the "Soft Start Config", "Overload Config", and "Protection Setup" menus. Parameter navigation and menus are located in **Appendix A** and **G**. The following setup procedures will use the factory default settings unless changed by you.
3. In the Overload Config menu, set the *Overld Trip FLA* parameter to the motor's nameplate rated current. This setting assumes the motor has a 1.15 Service Factor.
4. Set *Ovrlld Trip Class* parameter for the desired overload trip characteristic (curve).
5. In the Protection Setup menu set the *Motor Rated Volt* parameter to the motor's operating voltage.
6. If auto fault reset is required, set the *Reset Mode* parameter in the Soft Start Config menu to Auto (and *Start Control* to Level (default)). NOTE: Auto Reset is intended for unattended installations where there is no danger to personnel or other equipment when the motor starts without warning. If Auto Reset is enabled, CAUTION must be exercised to assure that any restart occurs in a safe manner.
7. Apply the Mains voltage and verify that no fault is present. If a fault is indicated, display the Diagnostics menu's *Device Status* parameter to determine the source of the fault. Each fault is described on **Page 8-6**.
 - a. A Phase Reversal Fault is a likely candidate on new installations. It can be remedied by either changing the *Phase Sequence* parameter from ABC to ACB in the Protection Setup menu or removing Mains power and switching the incoming line connections at L1 and L2 of the S811.
8. Quickly Jog (bump) the motor just enough to verify that the direction of rotation is correct. If it is not, remove all power to the S811 and the motor and swap two of the motor's winding connections.
9. Based on the desired starting mode, Voltage Ramp or Current Limit, complete the configuration of your S811 using the Soft Start Config menu:
 - a. Voltage Ramp Start Configuration
 - i. Initial parameter settings:
 - Start Method* = Voltage Ramp.
 - Initial Torque* = 50%
 - Soft Start Time* = 60 sec
 - Kick Start Torq* = 0% (fans and pumps), 75% (high breakaway loads)
 - Kick Start Time* = 0 sec (fans and pumps), 1 sec (high breakaway loads)
 - Soft Stop Time* = 60 sec

November 2006

- ii. Start the motor and determine the worst case starting conditions. Adjust Initial Torque for smooth start without hesitation. Rotation should begin within 2 seconds.
 - iii. If Stall Faults occur at the end of the ramp time, increase *Initial Torque*, *Kick Start Torq & Time* and/or *Soft Start Time* to get into bypass before the Soft Start Time elapses. Also, verify that the motor is not overloaded.
 - iv. Adjust the *Soft Stop Time* for the desired stopping time.
- b. Current Limit Start Configuration
- v. Initial settings:
 - Start Method* = Current Limit
 - Initial Torque* = 50%
 - Soft Start Time* = 120 sec
 - Kick Start Torq* = 0%
 - Kick Start Time* = 0 sec (disabled)
 - Soft Stop Time* = 60 sec
 - vi. Start the motor and determine the worst case starting conditions. Adjust *Initial Torque* for smooth start without hesitation. Rotation should begin within 2 seconds and the motor should smoothly accelerate to full speed.
 - vii. If Stall Faults occur, increase *Initial Torque* and/or *Soft Start Time* to get into bypass before the Soft Start Time elapses. Also, verify that the motor is not overloaded.
 - viii. After suitable performance has been achieved, determine the starting time to bypass and set *Soft Start Time* at 1.25 times this time. For example, if it takes 10 seconds to accelerate the motor and go into bypass, set the *Soft Start Time* for 12.5 seconds.
 - ix. Adjust the *Soft Stop Time* for the desired stopping time.
10. Review the Protection Options of the S811 and configure the appropriate ones for your application. Refer to **Table A-5** on **Page A-6** for the list of parameters used in configuring the protections features on your S811 Soft Starter. These parameters are located in the Protections menu of the DIM.
11. The S811 can be operated from a remote automated network. For network configuration details refer to **Appendix H** of this manual.

 Danger High Voltage	 Danger Haute Tension	 Peligro alto voltaje
The S811 has the ability to respond to commands from an automated network controller. Consequently the soft starter may start unexpectedly in response to these commands. To insure the safety of personnel and equipment, always remove power before accessing the electrical and/or mechanical equipment.	Le S811 à la capacité de répondre aux commandes d'un contrôleur de réseau automatisé. Donc le démarreur progressif peut démarrer soudainement en réponse à ces commandes. Pour s'assurer la sécurité du personnel et de l'équipement, toujours débrancher l'alimentation avant d'accéder à l'équipement électrique et/ou mécanique.	El S811 tiene la capacidad de responder a comandos de un controlador de red automatizado. Por lo tanto, el arrancador suave podría arrancar de improviso en respuesta a estos comandos. Para garantizar la seguridad del personal y del equipo, siempre desconecte la energía antes de acceder al equipo eléctrico o mecánico.

12. Refer to **Appendix H** of this manual for additional details on each of the S811's software parameters.
13. For additional support contact Customer Support.

November 2006

Chapter 8 — Troubleshooting

General







In this section of the manual, we present a procedure you can follow to diagnose a problem with your S811.

While many potential situations are outlined in this section, it is possible you may run into a problem that is not covered here. If you have worked through the following troubleshooting procedure and find that you require further assistance, please contact Eaton.

Please have the following information ready when you call:

Order No. (if available):
Catalog Number:
Style Number:
Serial Number:

Before You Begin to Troubleshoot

 Warning	 Avertissement	 Advertencia
Make sure you read and understand the procedures in this manual before you attempt to operate or set up the equipment.	Bien lire et comprendre les procédures contenues dans ce manuel avant de tenter le fonctionnement ou la mise en place de l'équipement.	Asegúrese de leer y entender los procedimientos en este manual antes de intentar operar o configurar el equipo.
 Danger High Voltage	 Danger Haute Tension	 Peligro alto voltaje
Do not work on energized equipment unless absolutely required. If troubleshooting procedure requires equipment to be energized, all work must be performed by properly qualified personnel, following appropriate safety practices and precautionary measures.	Ne pas travailler sur d'équipement sous tension sauf si c'est absolument nécessaire. Si des méthodes de dépannage exigent que l'équipement soit sous tension, tout travail doit être faire par du personnel qualifié, suivant des pratiques de sécurité et des mesures de précaution appropriées.	No trabaje en equipos en funcionamiento, a menos que sea absolutamente necesario. Si un procedimiento de solución de problemas requiere que el equipo permanezca encendido, todo el trabajo lo debe realizar personal adecuadamente calificado, respetando las prácticas de seguridad y las medidas preventivas correspondientes.

We highly recommend that you read this entire section of the manual before you begin to troubleshoot the *IT*. Soft Starter.

You may want to obtain the following equipment to aid you in troubleshooting:

- Multimeter
- Clamp-on ammeter

Always assume the S811 has high voltage applied and take proper precautions while troubleshooting the soft starter and associated equipment. Read all precautions at the front of this manual before starting the troubleshooting process.

The S811 Soft Starter can not be started until all faults have been reset. If a fault condition persists, fault reset is not possible and the Status LED remains red. Also, a local start requires that the start source (DIM, terminal block, Cover Control or other similar device) be in HAND mode (L bit in Motor Control Byte = 1). Pressing the START button on the DIM automatically puts that device in HAND.

Define the Problem

1. The S811 Soft Starter fails to respond in any way to a start command. Look at the front panel of the S811 Soft Starter and determine the state of the LEDs. The following troubleshooting flowcharts will walk the troubleshooter through each step and suggest probable solutions to each problem.

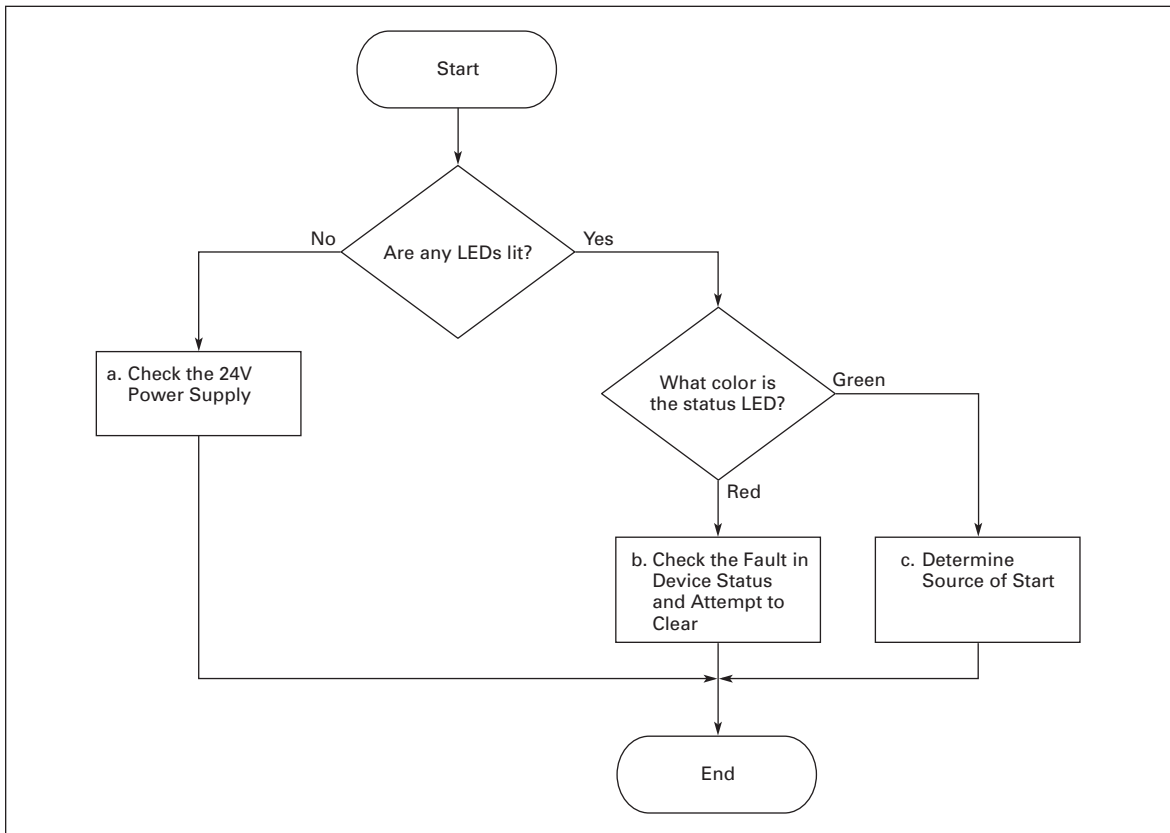

Figure 8-1: Start Command Troubleshooting Flowchart

- a. Check the 24V DC power supply for proper operation. Is the 24V power supply connected to the proper power source? Measure the 24V DC at the output terminals and on the soft starter input terminals. Check the screw terminal connections and polarity of the wiring. See Troubleshooting — Status LED OFF, **Table 8-2**.

November 2006

- b. With the status LED red, the device will not start. Attempt to reset the S811 Soft Starter by pressing the S811's recessed RESET button for one second or pressing the RESET soft key in the Display Mode screen of the DIM. If the LED remains red, use the DIM to determine the fault code and go to the Troubleshooting Fault Table, **Table 8-4**, to find the corrective action for each fault code.
- c. The LED is green and the S811 Soft Starter is ready to start. Find the Start source in **Table 8-1** to determine the appropriate corrective action. Verify that the "P" input terminal is at 24V DC. Then try to start the S811 using the DIM.

Table 8-1: Start Command Troubleshooting

Start Source Attempted	Suggested Corrective Action
DIM	<ul style="list-style-type: none"> • Verify the "P" (Permissive) input terminal is at 24V DC, either hard wired or wired through a normally closed STOP button. • Verify no other motor control device is preventing a start by clearing its permissive bit. Disconnect any other QCPort device that may prevent a start and purge [ⓐ] them from the S811's device list. This takes these devices out of the system and simplifies troubleshooting.
Connector Terminal Block	<ul style="list-style-type: none"> • Verify the "P" input terminal is at 24V DC when the start is attempted. • Verify the "3" input terminal is at 24V DC when start is attempted. • Verify 24V is applied to the "1" input terminal when the start is attempted. • If the <i>Start Control</i> parameter is set to Edge, verify the "1" input terminal sees a transition from 0V to 24V after all faults have been reset and the above conditions have been verified. • Verify no other motor control device is holding its permissive at 0. If it is, force its permissive = 1 or temporarily remove it from the S811 and purge [ⓐ] it from the S811's device list.
Other QCPort Motor Control Node	<ul style="list-style-type: none"> • Remove all external QCPort devices, purge [ⓐ] them from the S811's device list and attempt a start from the DIM. If the start is not successful, see DIM category above. Once that start is successful, reattach QCPort device(s) and retry start.
Fieldbus (DeviceNet, Profibus, etc.)	<ul style="list-style-type: none"> • Determine if the S811 can be started locally using the DIM. • Verify that the S811 was in AUTO when the fieldbus start was attempted (all motor control devices having their L bits = 0). • Verify no other motor control device is holding its permissive at 0. If it is, force its permissive = 1 or temporarily remove it from the S811 and purge [ⓐ] it from the S811's device list.

[ⓐ] Unplugging any source of motor control from QCPort will require that it be "purged" from the S811's motor control command device list (press and hold the S811's recessed RESET button for six seconds).

2. The S811 Soft Starter trips during starting and never reaches bypass. Use the DIM to determine the *Device Status* fault code and go to the Troubleshooting Fault Table, **Table 8-4**, to find the corrective action for each fault code.
3. The S811 Soft Starter trips during running operation while bypass contactors are engaged. Use the DIM to determine the *Device Status* fault code and go to the Troubleshooting Fault Table to find the corrective action for each fault code.
4. The S811 Soft Starter trips after the stop is commanded. Use the DIM to determine the *Device Status* fault code and go to the Troubleshooting Fault Table to find the corrective action for each fault code.
5. The S811 Soft Starter stops sooner than expected during a soft stop. If the *Soft Stop Time* is set too long for the motor loading, the motor will begin to stall when delaying SCR firing reduces the voltage. The S811 Soft Starter will detect this stalling and end the stop immediately and not set any faults.

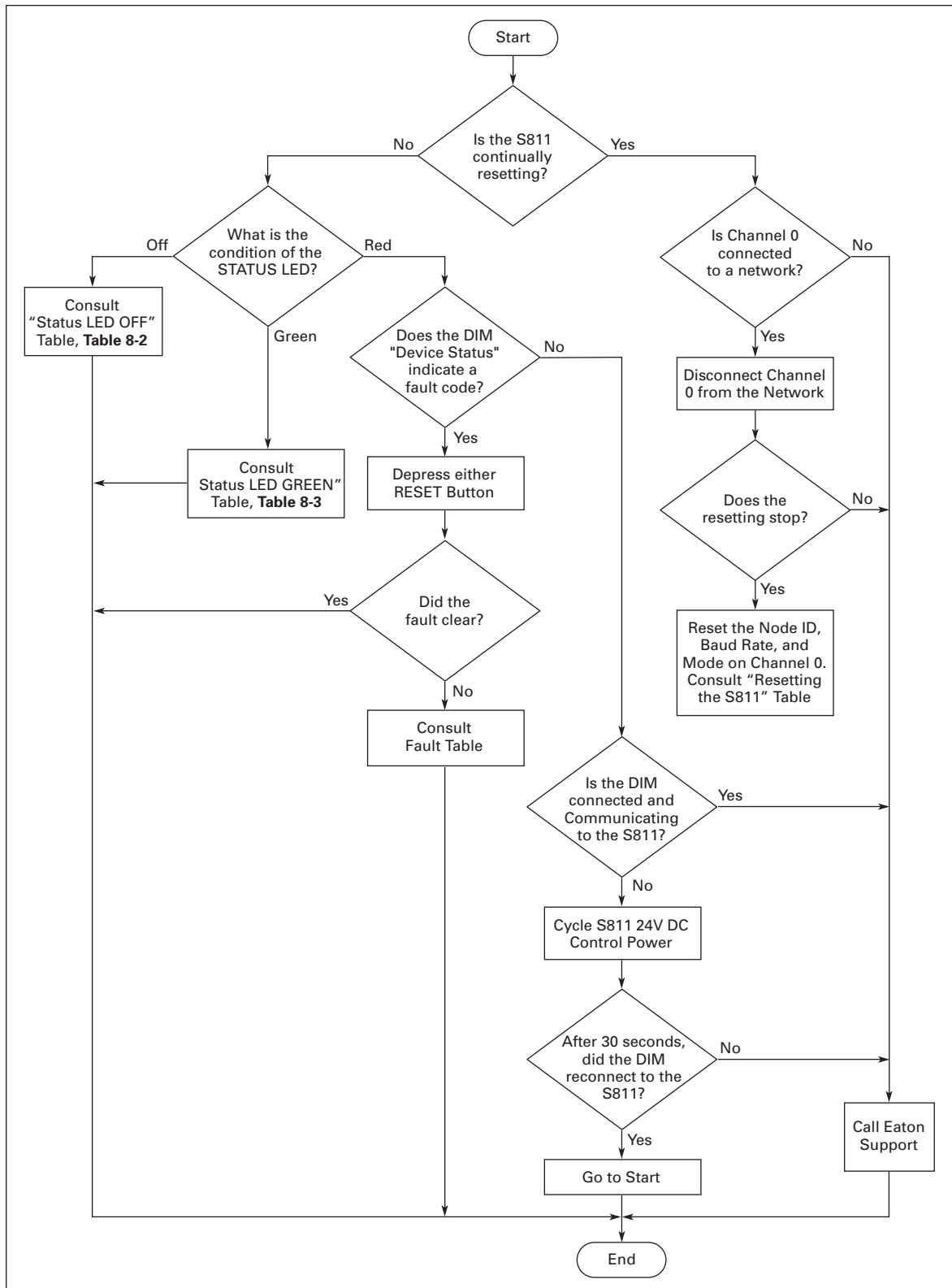

Figure 8-2: Main Troubleshooting Flowchart #1

November 2006

Table 8-2: Troubleshooting – Status LED OFF

Symptom/Indication	Possible Problem	Possible Solution
All LEDs never illuminate	The terminal block screws are not secure, not connected to proper terminals, reversed polarity. Possible Control Board failure.	Check control wiring. Verify the S811 24V DC power is present on the terminal block, the polarity is correct, and all terminals are tight. Possible fatal device failure.
Status LED never illuminates but CH0 and CH1 LEDs are actively flashing	Status LED is defective.	S811 can operate properly with a non-operational LED. Use DIM to observe the fault status of the S811. Possible fatal device failure.
Status LED and CH1 LED never illuminate, CH0 LED is constantly illuminated	Communications Firmware failure.	Possible fatal device failure.
CH0, CH1 LEDs never illuminate, Status LED illuminates	LED failure, communication failure on the Port.	S811 may still operate properly with a non-operational LED. Possible fatal device failure.

Table 8-3: Troubleshooting – Status LED GREEN

Symptom/Indication	Possible Problem	Possible Solution
Status LED green but S811 is not responding to Start from field wiring	Terminal block Hand input is low.	Check control wiring. To assert local control apply a constant 24V to the terminal block Hand input terminal 3.
Status LED green but S811 is not responding to Start from field wiring	24V is not being applied to the field wiring Start, Jog or Permissive terminal.	Verify if the soft starter is configured for Level sensitive or Edge sensitive field wiring. <ul style="list-style-type: none"> • If commanding Start or Jog with Level Sensitive Inputs: Check field wiring. Make sure terminal P, terminal 1, and terminal 3 have 24V applied. • If commanding Start with Edge Sensitive inputs: Make sure terminal 1 cycles from low to high while P and terminal 3 remain high.
Status LED green but S811 is not responding to Start from field wiring, DIM or network	A network device or field wiring is holding permissive low.	Make the field wiring permissive on the S811 and any cover controls are at 24V. Verify all hand control devices are sending permissive. A 0V permissive on any motor control device will inhibit a start or stop a running motor.

Fault Codes

Table 8-4: Troubleshooting Fault Table

Fault Code	Possible Problem	Possible Solution
1	Firmware Incompatibility or Hardware failure.	Call Eaton support.
3	Internal Communications Fault – Communications to DSP have been interrupted. Possible electrical noise or hardware failure.	Try a 24V DC control voltage power cycle to attempt to clear problem. Verify that the S811 is properly grounded. Call Eaton support if the problem persists.
4	Low Control Voltage Fault – The external 24V power supply voltage is dropping below the minimum required to control the motor.	Use recommended 24V power supplies with enough current sourcing capability to close contactors. Verify correct wire size used to connect power supply to S811. (See power supply specification for more details.) Verify connections are secure.
5	Power Pole Over Temperature Fault – The S811 has detected the internal SCR temperature is excessive. Operating environment above specified maximum temperature, ventilation holes blocked, fans are not operational, starts per hour exceed specifications, sensor failure on circuit board, bypass contactor(s) failed to close.	Ventilate to specified maximum temperatures, clear obstructions, verify fans are operational, verify control system is not exceeding the specified maximum starts per hour.
6	Phase Loss Fault – Extreme phase imbalance condition. Incoming phase disconnected, blown fuse.	Repair broken connection, replace fuse.
7	Phase Imbalance Fault – The imbalance of the incoming phases exceeds the trip threshold.	Correct imbalance problem with mains. Increase the <i>xx Imbalance Fault xx</i> parameters or disable the fault if the other issues cannot be resolved. Make sure your system can tolerate the imbalance.
9	Under Load Fault – Current supplied to the motor is below trip threshold. Linkage or belt driven by motor is broken, a clutch or other load engagement device is not operating, the motor is not loaded to the trip current.	Repair/replace broken belts, linkage, or clutch, and/or increase load. Reduce <i>Low I Trip % FLA</i> to an acceptable value (0% will disable).
10	Over Current Fault – only active in bypass if the Jam Fault is disabled. Current exceeds the fault threshold.	Disconnect power from S811 and any other equipment. Remove obstruction in motor drive train. Verify S811 is properly sized for the application.
11	Jam Fault – While in bypass an obstruction has slowed or stalled the motor resulting in extreme motor current.	Disconnect power from S811 and any other equipment and remove obstruction. Jam Fault can be disabled if trips occur during normal operation. Over Current Fault will provide protection at a higher current threshold.
13	Bypass Failure Fault – S811 detected that the internal bypass contact(s) did not close. Possibly opened due to excessive shock or 24V DC control voltage sag (insufficient voltage to maintain contact closure).	Verify control power and wire size meets specifications. Reduce shock or vibration. Call Eaton support if the problem persists.

November 2006

Table 8-4: Troubleshooting Fault Table, continued

Fault Code	Possible Problem	Possible Solution
14	Overload Fault – Motor has been overloaded for an extended period of time.	Reduce the motor's load. Verify the <i>Overld Trip FLA</i> and/or <i>Ovrlld Trip Class</i> if the overloads are infrequent and are set to match the motor and system. Note: Exceeding nameplate ratings will shorten equipment life. If fault happens during motor start: verify the control system is not exceeding the specified maximum starts per hour. Increase the initial torque to bring the motor up to speed faster.
18	Instantaneous Over Current Fault – Starting current excessive. Load too great.	Reduce starting load, increase soft starter capacity (be sure model ratings can handle current demands). Call Eaton support for application assistance.
32	Internal NV Memory Fault – Internal memory error.	Call Eaton support.
36	Communications Loss Stop Fault – Communications to a remote network controller was lost while motor was running. Device was disconnected or the connection broken.	Reattach network controller, replace connection cable. Call Eaton support if the problem persists.
38	Temperature Sensor Fault – Temperature sensor or interconnection failure.	Call Eaton support. Fault can be disabled, but S811 will not be protected against failures caused by excessive internal temperatures.
39	Internal CPU Fault – Firmware Incompatibility or Hardware failure.	Call Eaton support.
42	Under Voltage Fault – Incoming AC line voltage below trip threshold. Device connected to incorrect mains supply voltage.	Connect to correct supply voltage. Verify <i>Motor Rated Volt</i> is set to correct value. It may be necessary to reduce this setting for soft mains.
43	Over Voltage Fault – Incoming AC line voltage above trip threshold. Device connected to incorrect mains supply voltage.	Connect to correct supply voltage. Verify <i>Motor Rated Volt</i> is set to correct value. It may be necessary to increase this setting for high mains.
44	Motor Voltage Phase Reversal Fault – incoming line phase rotation sequence opposite of device setting.	Set <i>Phase Sequence</i> to match incoming sequence. If motor is turning in wrong direction swap two motor connection leads. If mains leads need to be changed, swap incoming leads and set <i>Phase Sequence</i> to match incoming sequence. If an upstream reverser is used, disable <i>Phase Rev Fault</i> .
55	Motor Control Command Device Missing Fault – A motor control command device (DIM, Cover Control, or similar device) was removed.	Re-attach motor control command device and reset the fault. If the motor command device is to be permanently removed, purge it from the S811's motor control command device list (press and hold the recessed RESET button on the front of the S811 for six seconds). The STATUS LED will change to amber when the action has started and any detached motor control device has been removed from the S811's list.
56	Internal Communications Fault 2 – The motor was stopped because of an internal communications error. Possible electrical noise or hardware failure.	Try a 24V DC control voltage power cycle to attempt to clear problem. Verify the S811 is properly grounded. Call Eaton support if the problem persists.

Table 8-4: Troubleshooting Fault Table, continued

Fault Code	Possible Problem	Possible Solution
57	Internal Program Memory Fault – one or more internal memory locations have been corrupted.	Cycle 24V DC power to the S811. Call Eaton support if fault persists.
58	SCR Not Firing Fault – SCR is not conducting when gated. Incoming phase lost. Special application – undersized or high impedance motor, SCR malfunctioning, circuitry damaged by megger testing.	Re-apply lost phase. Review S811 application. Call Eaton support if problem persists.
59	Shorted SCR fault – SCR is shorted from over current abuse, bypass contactor welded shut, application/configuration issues.	Call Eaton support if problem persists.
60	SCR Over Current Fault – Excessive SCR Current prior to bypass. Only active when Stall Fault is disabled. Motor should be up to speed prior to bypass.	Increase <i>Soft Start Time</i> and/or <i>Initial Torque</i> . Reduce starting load. Verify S811 is properly sized.
61	Mains AC Voltage Loss Fault – fuses blown, disconnect open, or breaker tripped.	Replace fuses, close disconnect, or reset breaker.
63	Motor Stall Fault – S811 could not engage the bypass contactors at the end of the motor start time because the start current was too high. Motor did not reach full speed during the start time.	Lengthen <i>Soft Start Time</i> and/or increase <i>Initial Torque</i> . Loads that are heavily loaded during a start such as fans will often need an initial torque setting much greater than the factory default.
64	Voltage Zero Cross Lost Fault – Mains lost, phase L1 or L3 lost.	Restore mains or lost phases. Call Eaton support if problem persists.

Table 8-5: Resetting the S811

#1 Place all DIP switches on the front cover of the S811 in the OFF position	
#2 Using the table below, toggle (ON-OFF) the indicated switch 5 times to perform the desired Reset	
#3 After the reset is complete, set the DIP switches back to the desired QCPort Node ID (1-63)	
Switch "1"	Factory Reset (Reset to default Factory (Out-of-Box) state)
Switch "2"	Application Configuration Reset (Resets all application parameters to defaults. Leaves QCP network parameters unchanged.)
Switch "4"	Commission Reset (Reset Mode and Baud Rate only)
Switch "8"	Network Config Reset (Reset Node ID, Baud and Mode only)

November 2006

Chapter 9 — Parts and Service

Renewal Parts

Table 9-1: DIM – Digital Interface Module Renewal Parts

Description	Catalog Number
DIM for S811 Soft Starter	EMA91
12-Pin Locking Terminal Block	EMA75L

Service

For additional information on this product, please call our Customer Support Center at: 1-800-356-1243 or visit our web site at: www.EatonElectrical.com.

For technical assistance, please contact the Technical Resource Center at (800) 809-2772.

Service and repair is available from Eaton or several factory authorized regional service centers. Please contact Eaton's Product Integrity Center at (800) 345-0434 for the location nearest to you.

For field service or start-up assistance 24 hours a day, 7 days a week, please call (800) 498-2678.

November 2006

Appendix A — Parameters

Parameter List

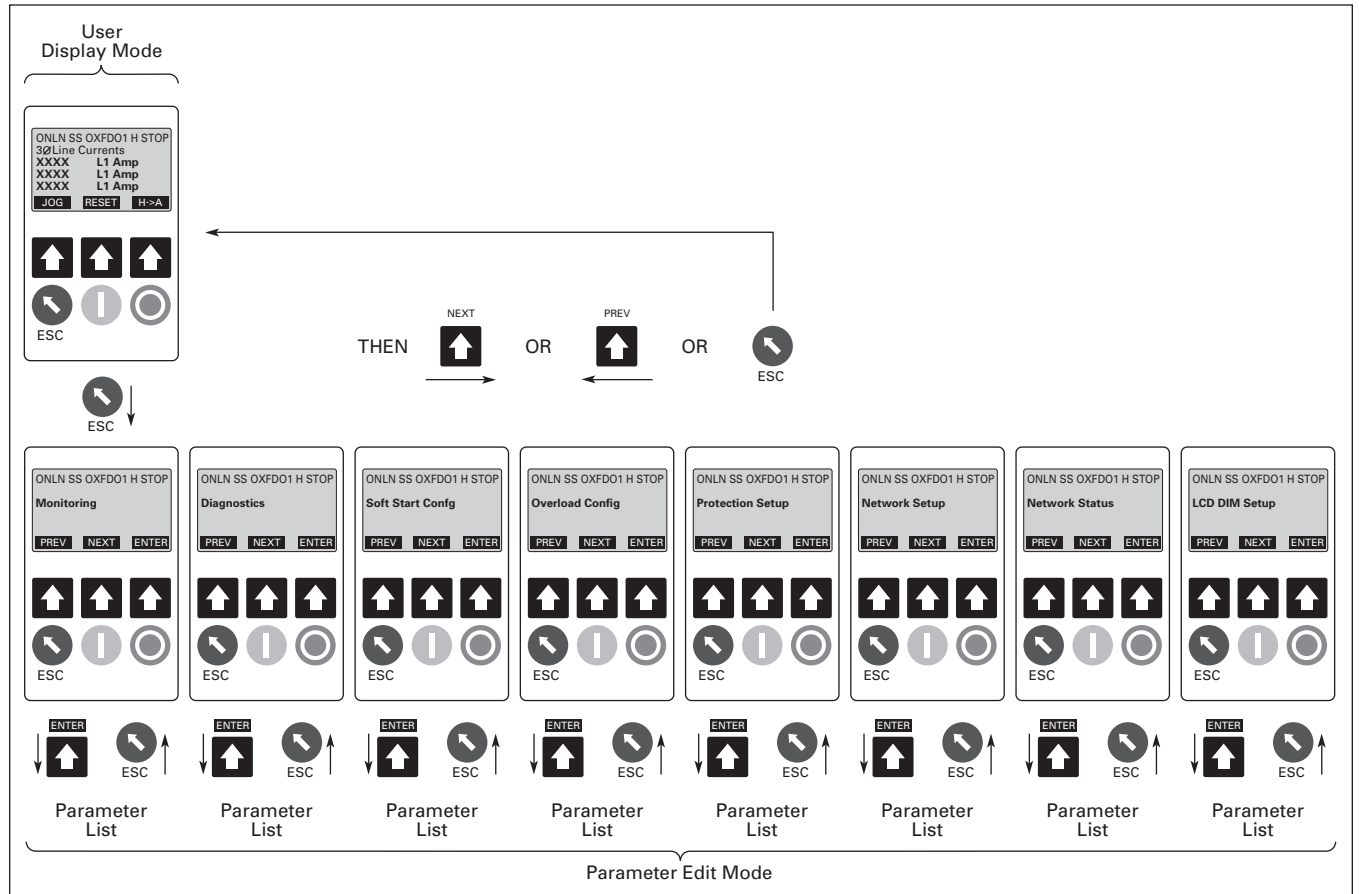

Figure A-1: Navigation Overview

Monitoring Menu

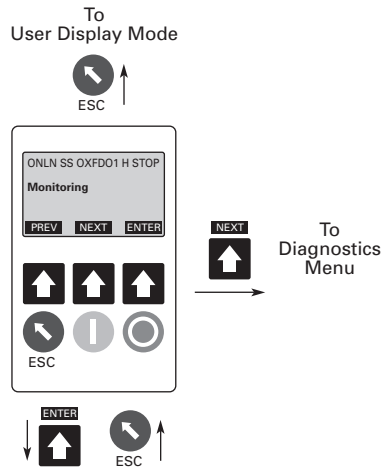

Table A-1: Monitoring — Menu 1

	Parameter	Units	Access Level
1	3Ø Line Currents	Amps	0
2	3Ø Pole Voltages	Volts	0
3	Thermal Memory	%	0
4	Current as % FLA	%	0
5	Pole Temp °C	°C	0
6	DC Cntrl Voltage	Volts	0
7	Device Temp °C	°C	0
8	Start Count	Starts	0
9	3Ø Pole Currents	Amps	0
10	Ave Pole Current	Amps	0
11	Ave Line Current	Amps	0

Note: The button under the PREV Soft Key moves up one line.



The button under the NEXT Soft Key moves down one line.



Note: See **Appendix I** for data parameter descriptions.

November 2006

Diagnostics Menu

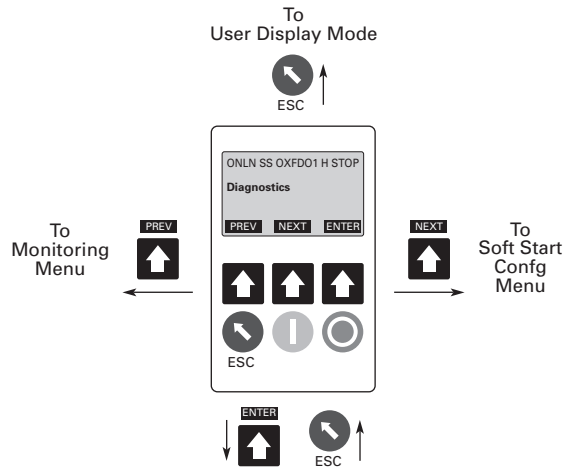

Table A-2: Diagnostics — Menu 2

	Parameter	Units	Access Level
1	<i>Device Status</i>		0
2	<i>Fault/Warn List</i>		0
3	<i>Fault/Warn Queue</i>		0
4	<i>Motor Fault Bits</i>		3
5	<i>Motor Status</i>		0
6	<i>Motor Control</i>		3
7	<i>Breaker Status</i>		3

Note:  The button under the PREV Soft Key moves up one line.



 The button under the NEXT Soft Key moves down one line.



Note: See **Appendix I** for data parameter descriptions.

Soft Start Config Menu

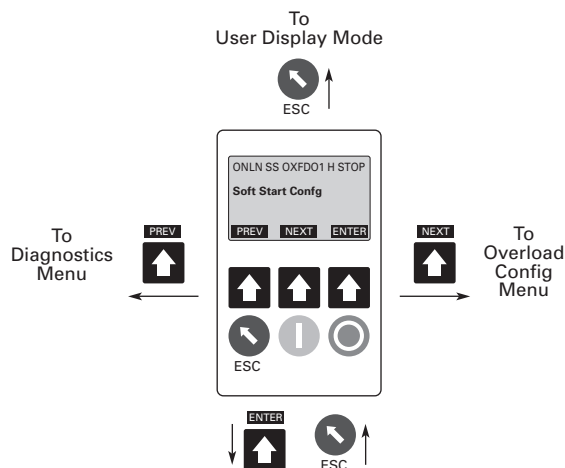

Table A-3: Soft Start Config — Menu 3

	Parameter	Units	Min	Max	Default	Access Level
1	<i>Start Method</i>		0	3	0	2
2	<i>Soft Start Time</i>	Sec	0.5	180	20	1
3	<i>Initial Torque</i>	%	0	100	45	1
4	<i>Pump Stop Time</i>	Sec	5	120	10	1
5	<i>Soft Stop Time</i>	Sec	0	60	0	1
6	<i>Kick Start Time</i>	Sec	0	2	0	1
7	<i>Kick Start Torq</i>	%	0	100	0	1
8	<i>Start Control</i>		0	1	1	2
9	<i>Reset Mode</i>		0	1	0	2
10	<i>Relay1 Config</i>		0	5	2	2
11	<i>Relay2 Config</i>		0	5	0	2

Note:  The button under the PREV Soft Key moves up one line.



Note:  The button under the NEXT Soft Key moves down one line.



Note: See **Appendix I** for data parameter descriptions.

November 2006

Overload Config Menu

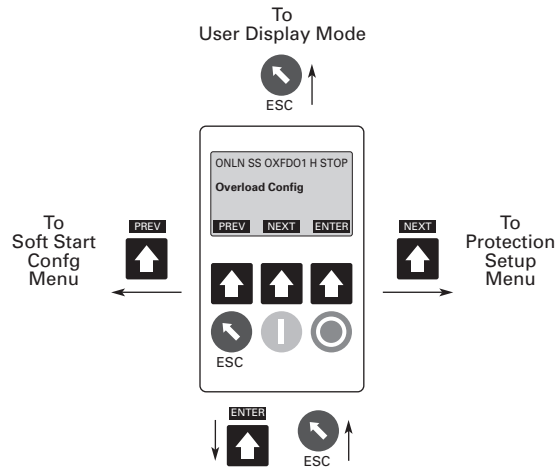

Table A-4: Overload Config — Menu 4

	Parameter	Units	Min	Max	Default	Access Level
1	<i>Overld Trip FLA</i>	Amps	12	1000	21	2
2	<i>Ovrld Trip Class</i>		5	30	20	2
3	<i>Overload Fault</i>		0	1	1	2
4	<i>Ovld On Start</i>	Sec	0	1	1	2

Note: The button under the PREV Soft Key moves up one line.



The button under the NEXT Soft Key moves down one line.



Note: See **Appendix I** for data parameter descriptions.

Protection Setup Menu

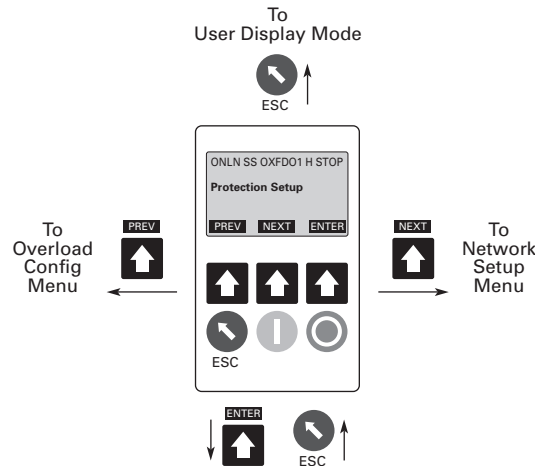

Table A-5: Protection Setup — Menu 5

	Parameter	Units	Min	Max	Default	Access Level
1	Phase Sequence		0	1	0	2
2	Phase Rev Fault		0	1	0	2
3	Motor Rated Volt	Volts	115	600	480	2
4	Low Volt Trip		0	1	1	2
5	Low Volt Level	%	1	99	90	2
6	Low Volt Trip Dly	Sec	1	60	3	2
7	Hi Volt Trip		0	1	1	2
8	Hi Volt Level	%	101	120	110	2
9	Hi Volt Trip Dly	Sec	1	60	3	2
10	V Imbal Trip Lev	%	1	100	6	2
11	V Imbal Trip Dly	Sec	1	60	0.5	2
12	Phase Loss Fault		0	1	1	2
13	Phase Loss % Trp	%	1	100	80	2
14	Phase Loss Trip Dly	Sec	1	60	0.5	2
15	Low I Trip % FLA	%	0	100	6	2
16	Phase Imb Fault		0	1	1	2
17	I Imbal Trip Lev	%	1	100	40	2
18	I Imbal Trip Dly	Sec	1	60	0.5	2
19	SCR Short Fault		0	1	1	2
20	SCR Conduct Fault		0	1	1	2
21	Jam Fault		0	1	1	2
22	Stall Fault		0	1	1	2
23	Temp Sense Fault		0	1	1	2

Note: The button under the PREV Soft Key moves up one line.



The button under the NEXT Soft Key moves down one line.



Note: See Appendix I for data parameter descriptions.

November 2006

Network Setup Menu

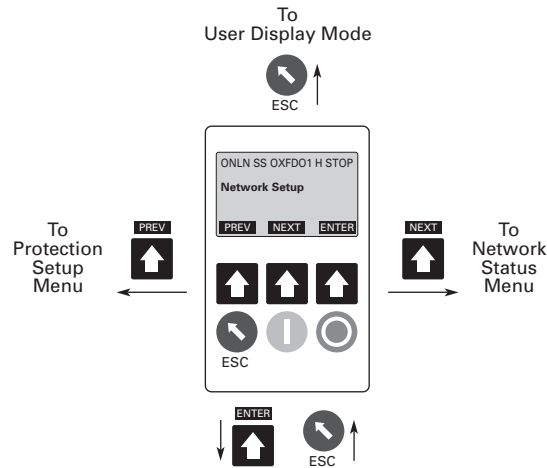

Table A-6: Network Setup — Menu 6

	Parameter	Units	Min	Max	Default	Access Level
1	Language Select					1
2	Comm Loss Action		0	7	0	3
3	Mot Ctrl Timeout	mSec			2000	3
4	Trans MC Timeout	mSec	①		2000	3
5	Term Resistor		0	1	1	3
6	Baud Rate		0	6		3
7	Device Mode		0	4		3
8	Production Intvl	mSec				3
9	Consumpt Intvl	mSec				3
10	Production List					3
11	Consumption List					3

① A 0 setting will disable this feature until the next factory reset.

Note:  The button under the PREV Soft Key moves up one line.



Note:  The button under the NEXT Soft Key moves down one line.



Note: See **Appendix I** for data parameter descriptions.

Network Status Menu

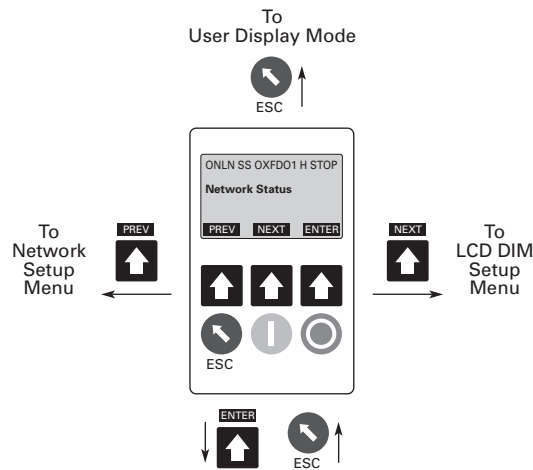

Table A-7: Network Status — Menu 7

	Parameter	Access Level
1	<i>Firmware Version</i>	0
2	<i>Hardware Version</i>	0
3	<i>QCP Fault Status</i>	3
4	<i>Node ID</i>	3
5	<i>Device ID Tag</i>	3
6	<i>Slave Address</i>	3
7	<i>Production Dest</i>	3
8	<i>Device Identity</i>	3
9	<i>Config CRC</i>	0
10	<i>Parameter List</i>	3
11	<i>Language List</i>	3

Note:  The button under the PREV Soft Key moves up one line.



Note:  The button under the NEXT Soft Key moves down one line.



Note: See **Appendix I** for data parameter descriptions.

November 2006

LCD DIM Setup Menu

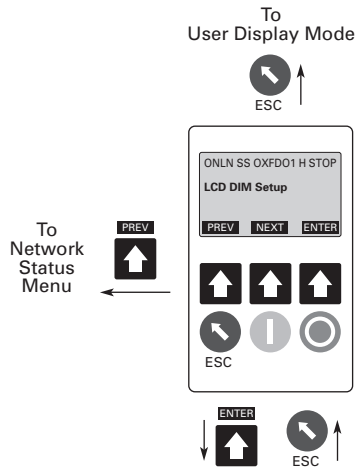

Table A-8: LCD DIM Setup Menu

	Parameter	Units	Min	Max	Default	Access Level
1	Access Level				2	0
2	Password					0
3	Access Timeout	Secs	0	600	600	3
4	User Var 1				100	3
5	User Var 1 Scale				1	3
6	User Var 1 Desc					3
7	User Var 1 Units					3
8	User Var 2				0	3
9	User Var 2 Scale				1	3
10	User Var 2 Desc					3
11	User Var 2 Units					3
12	Backlight Level				3	0
13	Backlight Time	Secs	0	300	0	0
14	Screen Contrast				15	0
15	Scan For Devices					2
16	Identify Node					0
17	Start Discovery					2
18	Reset-Soft					2
19	Reset-Factory					3
20	Reset-App Cfg					2
21	Reset-App Fault					2

Note: Contact Factory for more information on DIM Setup Parameters.

Table 6-5: LCD DIM Setup Menu, continued

	Parameter	Units	Min	Max	Default	Access Level
22	Reset-Commission					2
23	Clear Fault Que					0
24	Get Register					2
25	Set Register					3
26	Run Delay	Secs			0.3	3
27	Transient Source				Disabled	3
28	Refresh Rate	mSec			250	3
29	Firmware Version					0
30	Term Resistor				Enabled	1
31	Inactive Timeout	Secs	0 ^①	65535	0	2
32	Fault Disp Time	Secs	0	30	0	2
33	Production Data					3
34	Consumption Data					3
35	Status					3
36	App Status					0
37	Motor Control					2
38	Motor Status					2
39	Device Temp °C					0
40	Device Identity					2
41	Config CRC					2
42	Node ID					0
43	Device Mode					3
44	Baud Rate					3
45	Production Dest					2
46	Device ID Tag				LCD DIM	0
47	Production Intvl	mSec			100	3
48	Consumpt Intvl	mSec			2000	3
49	Language List				0	0
50	Language Select				0	0

^① Do not set less than 10 seconds. Except: 0 setting disables timeout.

Note:  The button under the PREV Soft Key moves up one line.



Note:  The button under the NEXT Soft Key moves down one line.



Note: Contact Factory for more information on DIM Setup Parameters.

November 2006

Appendix B — Protection

Thermal Overload

The *IT*. Soft Starter features an electronic motor overload protection feature. This is intended to protect the motor and power wiring against overheating caused by excessive current for extended periods of time.

Note: Short circuit protection must be applied on the line side of the soft starter.

Entering the motor full load current rating, using the *Overld Trip FLA* parameter programs trip current. It is programmable from 32% – 100% of the unit’s rated current.

Table B-1: Overload — Adjustment Settings

Frame Size	Catalog Number	FLA Current Range for a Line Connection	FLA Current Range for an Inside-the-Delta Connection
N	S811N37xxx	11 – 37	19 – 65
	S811N66xxx	20 – 66	35 – 114
R	S811R10xxx	32 – 105	55 – 182
	S811R13xxx	42 – 135	73 – 234
T	S811T18xxx	56 – 180	97 – 311
	S811T24xxx	75 – 240	130 – 415
	S811T30xxx	95 – 304	164 – 526
U	S811U36xxx	112 – 360	193 – 623
	S811U42xxx	131 – 420	227 – 727
	S811U50xxx ^①	156 – 500	270 – 865
V	S811V36xxx	112 – 360	193 – 623
	S811V42xxx	131 – 420	227 – 727
	S811V50xxx	156 – 500	270 – 865
	S811V65xxx	203 – 650	352 – 1125
	S811V72xxx	225 – 720	389 – 1246
	S811V85xxx	265 – 850	458 – 1471
	S811V10xxx ^②	320 – 1000	554 – 1730

^① Rating does not have IEC certification.

^② See Application Notes, **Appendix E**.

Note: *Overload Trip FLA* parameter is settable to any point within its range.

The thermal overload is designed to protect the motor from overheating caused by excessive current. If the motor is overloaded, the current drawn rises and heats the motor. The FLA sets the trip threshold and the trip class (5 to 30) is set with the *Ovrld Trip Class* parameter.

If the device trips on a thermal overload, an internal timer is started which inhibits a reset for three minutes. After this timer expires, the device may be reset and the thermal fault is cleared. At this point another internal timer is started, this timer is 26 x 3 or 48 minutes. If another trip occurs before this timer expires, the reset inhibit time is increased to 6 minutes.

Once the trip level reaches 3, it will take 144 minutes to go back to level 2, then 96 minutes to get back to level 1. To get from level 3 to a reset thermal overload at level 1, it takes 240 minutes without a trip. A reset thermal overload at level 1 means the next thermal overload trip will have a 3-minute reset inhibit as in **Table B-2**.

Table B-2: Thermal Motor Overload Times

Trip Level	Reset Inhibit Time	Reset Time to Previous Trip Level
1	3 minutes	—
2	6 minutes	96 minutes
3	9 minutes	144 minutes ^①

^① Total 240 minutes to reset to level 1.

Cycling power on the device will NOT clear the thermal trip. The thermal memory and the reset inhibit time are saved to the non-volatile memory. These values are reloaded when the device boots and the timer is restarted at the full reset time. This means if the 3-minute inhibit timer has been running two minutes, cycling power will require the user to wait the full three minutes before a reset can clear the overload fault.

If the device is shut down when the overload fault is tripped, the temperature is also saved to the non-volatile memory. If the device is left to cool and then powered, the temperature read from the sensor is compared to the saved temperature. If the current temperature is 87% or less of the saved temperature, a full thermal memory reset is initiated.

November 2006

Overload Trip Curves

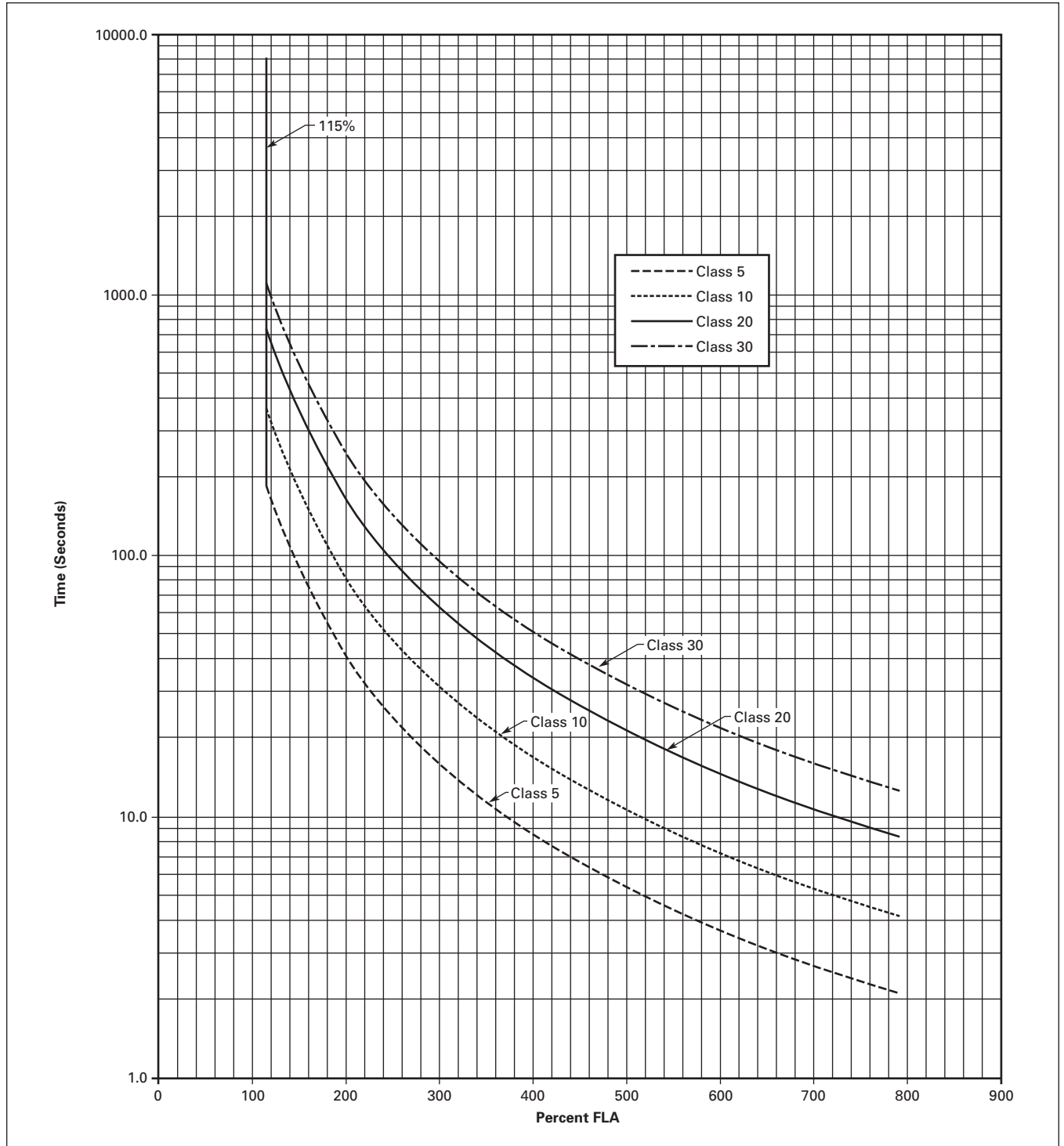

Figure B-1: Overload Trip Curves

S811 and Motor Protection Features

The S811 implements the following protection features. Each protection feature is individually configured and enabled by the user. Some of the features are designed to protect the motor and others are for internal protection of the S811. A summary can be found in **Table B-17**.

Motor Parameters

One or more of the motor protection features need the following motor parameters. The user must input these values prior to enabling protection.

Table B-3: Motor Parameters Required for Protection

Setting	DIM Parameter	Range	Step	Default
Rated Voltage (RMS Line-to-Line)	<i>Motor Rated Volt</i>	115 – 690	1 volt	480 volts
Phase Sequence	<i>Phase Sequence</i>	{ABC, ACB}	N/A	ABC

Instantaneous Over Current

When the bypass contactors are not engaged, the S811 monitors the maximum RMS value of the three phase currents. The unit will trip with an instantaneous over current fault if the maximum value exceeds six times the catalog FLA setting for 1.5 seconds. This internal protection mechanism is most useful for protecting the S811 from starting motor too large for its ratings.

Table B-4: Instantaneous Over Current Settings

Trip	DIM Parameter	Set Point	Default
Trip Threshold	Not User Settable	6x catalog FLA	N/A
Trip Delay	Not User Settable	1.5 Seconds	N/A

Motor Stall

The S811 monitors the maximum RMS value of the three phase currents. The unit will trip with a motor stall fault if the stall fault is enabled and the maximum RMS value exceeds two times the FLA setting when the start time setting expires.

Table B-5: Motor Stall Settings

Trip	DIM Parameter	Set Point	Default
Trip Enable	<i>Stall Fault</i>	{On, Off}	On
Trip Threshold	Not User Settable	2x FLA	N/A

SCR Over Current

The SCR over current trip is only active if the stall fault trip is disabled. The S811 monitors the maximum RMS value of the three phase currents. The unit will trip with a SCR over current fault if the stall fault is disabled and the maximum RMS value exceeds three times the FLA setting when the start time setting expires.

Table B-6: SCR Over Current Settings

Trip	DIM Parameter	Set Point	Default
Trip Threshold	Not User Settable	3x FLA	N/A

November 2006

Motor Jam

When the bypass contactors are closed, the S811 monitors the maximum RMS value of the three phase currents. The unit will trip with a motor jam fault if the jam trip is enabled and the maximum RMS value exceeds three times the FLA setting for 1.5 seconds.

Table B-7: Motor Jam Settings

Trip	DIM Parameter	Set Point	Default
Trip Enable	<i>Jam Fault</i>	{On, Off}	On
Trip Threshold	Not User Settable	3x FLA	N/A
Trip Delay	Not User Settable	1.5 Seconds	N/A

Motor Over Current

The motor over current trip is active only if the jam fault trip is disabled. When the bypass contactors are closed, the S811 monitors the maximum RMS value of the three phase currents. The unit will trip with a motor over current fault if the maximum RMS value exceeds four times the catalog FLA for the class dependent trip delay.

Table B-8: Motor Over Current Settings

Trip	DIM Parameter	Set Point	Default
Trip Threshold	Not User Settable	4x Catalog FLA	N/A
Trip Delay	Not User Settable		N/A
– Class ≤ 5		2.0 seconds	
– Class ≤ 10		4.0 seconds	
– Class ≤ 20		6.0 seconds	
– Class ≤ 30		8.0 seconds	

Motor Under Load

When the bypass contactors are closed, the S811 monitors the average value of the three phase currents as a percent of FLA. The unit will trip with a motor under load fault if the percent FLA value falls below the trip threshold for greater than two seconds.

Table B-9: Motor Under Load Settings

Trip	DIM Parameter	Set Point	Step	Default
Trip Threshold	<i>Low I Trip % FLA</i>	1 – 100%	1%	6%
Trip Delay	Not User Settable	2.0 Seconds	N/A	N/A

Phase Imbalance — Current

NEMA defined current imbalance is calculated using the following equation:

$$\text{Percent Imbalance} = 100 * (\text{max deviation from average} / \text{average})$$

The S811 monitors the current imbalance when the motor is running. The unit will trip with a motor phase imbalance fault if the current imbalance trip is enabled, the percent imbalance exceeds the trip threshold for the trip delay and the current is greater than the FLA trip setting.

Table B-10: Current Imbalance Settings

Trip	DIM Parameter	Set Point	Step	Default
Trip Enable	<i>Phase Imb Fault</i>	{On, Off}	N/A	On
Trip Threshold	<i>I Imbal Trip Lev</i>	1 – 100%	1%	40%
Trip Delay	<i>I Imbal Dly</i>	0.0 – 60.0 Seconds	0.1 Second	0.5 Second

Phase Loss

NEMA defined current imbalance is calculated using the following equation:

$$\text{Percent Imbalance} = 100 * (\text{max deviation from average} / \text{average})$$

The S811 monitors the current imbalance when the motor is running. Phase loss is an extreme case of current imbalance. The unit will trip with a motor phase loss fault if the phase loss trip is enabled, the percent imbalance exceeds the trip threshold for the trip delay and current increases above FLA trip setting.

Table B-11: Phase Loss Settings

Trip	DIM Parameter	Set Point	Step	Default
Trip Enable	<i>Phase Loss Fault</i>	{On, Off}	N/A	On
Trip Threshold	<i>Phase Loss % Trp</i>	1 – 100%	1%	80%
Trip Delay	<i>Phase Loss Dly</i>	0.0 – 60.0 Seconds	0.1 Second	0.5 Second

Motor Voltage Phase Reversal

The S811 monitors the phase voltages to determine the incoming phase sequence (ABC or ACB). If the monitored sequence differs from the *Incoming Phase Sequence* parameter setting, a motor phase reversal fault is issued. The phase reversal trip will need to be disabled when using an upstream reverser.

Table B-12: Motor Voltage Phase Reversal Settings

Trip	DIM Parameter	Step	Default
Trip Enable	<i>Phase Rev Fault</i>	{On, Off}	On

Phase Imbalance — Voltage

NEMA defined voltage imbalance is calculated using the following equation:

$$\text{Percent Imbalance} = 100 * (\text{max deviation from average} / \text{average})$$

The S811 monitors the voltage imbalance when the motor is off and checks the value just prior to starting to determine if a fault shall be issued. The unit will trip with a motor phase imbalance fault if the phase imbalance trip is enabled and the percent imbalance has exceeded the trip threshold for the trip delay.

Table B-13: Voltage Imbalance Settings

Trip	DIM Parameter	Set Point	Step	Default
Trip Enable	<i>Phase Imb Fault</i>	{On, Off}	N/A	On
Trip Threshold	<i>V Imbal Trip Lev</i>	1 – 100%	1%	6%
Trip Delay	<i>V Imbal Dly</i>	0.0 – 60.0 Seconds	0.1 Second	0.5 Second

November 2006

Under Voltage

The S811 monitors the minimum RMS value of the three phase voltages. The unit will trip with a motor under voltage fault if the under voltage trip is enabled and the minimum RMS value drops below the trip threshold for the trip delay. Note that the S811 will not generate an under voltage trip when the motor is starting.

Table B-14: Under Voltage Settings

Trip	DIM Parameter	Set Point	Step	Default
Trip Enable	<i>Low Volt Trip</i>	{On, Off}	N/A	On
Trip Threshold	<i>Low Volt Level</i>	1 – 99% Rated	1%	90%
Trip Delay	<i>Low Volt Trip Dly</i>	0.0 – 60.0 Seconds	0.1 Second	3.0 Second

Over Voltage

The S811 monitors the maximum RMS value of the three phase voltages. The unit will trip with a motor over voltage fault if the over voltage trip is enabled and the maximum RMS value rises above the trip threshold for the trip delay.

Table B-15: Over Voltage Settings

Trip	DIM Parameter	Set Point	Step	Default
Trip Enable	<i>Hi Volt Trip</i>	{On, Off}	N/A	On
Trip Threshold	<i>Hi Volt Level</i>	101 – 120 %Rated	1 %	110%
Trip Delay	<i>Hi Volt Trp Dly</i>	0.0 – 60.0 Seconds	0.1 Second	3.0 Second

Mains Faults

If a start is commanded and voltage mains are not present or are not in a safe range for the S811 to attempt a start, a fault will be generate according to the following table.

Table B-16: Fault Generation

Fault	Condition
Mains Loss	Average RMS of three phase voltages is less than 80 volts
Motor Under Voltage	Minimum phase RMS voltage is less than 80 volts
Motor Over Voltage	Maximum phase RMS voltage is greater than 800 volts

Table B-17: S811 Protection Faults

Fault	Active	Trip	DIM Parameter	Set Point	Step	Default
#18 Inst Over Current	On SCRs	Threshold	Not User Settable	6x FLA	N/A	N/A
		Delay	Not User Settable	1.5 Seconds	N/A	N/A
#63 Motor Stall	End of start time setting	Enable	<i>Stall Fault</i>	{On, Off}	N/A	On
		Threshold	Not User Settable	2x FLA	N/A	N/A
#60 SCR Over Current	End of start time setting (stall disabled)	Threshold	Not User Settable	3x FLA	N/A	N/A
#11 Motor Jam	Bypass engaged	Enable	<i>Jam Fault</i>	{On, Off}	N/A	On
		Threshold	Not User Settable	3x FLA	N/A	N/A
		Delay	Not User Settable	1.5 Seconds	N/A	N/A
#10 Motor Over Current	Bypass engaged (Jam Disabled)	Threshold	Not User Settable	4x Catalog FLA	N/A	N/A
		Delay Class	Not User Settable		N/A	N/A
		- ≤ 5		2.0 seconds		
		- ≤ 10		4.0 seconds		
		- ≤ 20		6.0 seconds		
		- ≤ 30		8.0 seconds		
#9 Motor Under Load	Bypass engaged	Threshold	<i>Low I Trip % FLA</i>	1 – 100%	1%	6%
		Delay	Not User Settable	2.0 seconds	N/A	N/A
#7 Current Imbalance	Motor energized	Enable	<i>Phase Imb Fault</i>	{On, Off}	N/A	On
		Threshold	<i>I Imbal Trip Lev</i>	1 – 100%	1%	40%
		Delay	<i>I Imbal Dly</i>	0.0 – 60.0 Seconds	0.1 Second	0.5 Second
#6 Phase Loss	Motor energized	Enable	<i>Phase Loss Fault</i>	{On, Off}	N/A	On
		Threshold	<i>Phase Loss % Trp</i>	1 – 100%	1%	80%
		Delay	<i>Phase Loss Dly</i>	0.0 – 60.0 Seconds	0.1 Second	0.5 Second
#44 Phase Reversal	Mains Present; when monitored sequence differs from Incoming Phase Sequence parameter	Enable	<i>Phase Rev Fault</i>	{On, Off}	N/A	On
#7 Voltage Imbalance	When start is attempted	Enable	<i>Phase Imb Fault</i>	{On, Off}	N/A	On
		Threshold	<i>V Imbal Trip Lev</i>	1 – 100%	1%	6%
		Delay	<i>V Imbal Dly</i>	0.0 – 60.0 Seconds	0.1 Second	0.5 Second
#42 Under Voltage	Bypass engaged	Enable	<i>Low Volt Trip</i>	{On, Off}	N/A	On
		Threshold	<i>Low Volt Level</i>	1 – 99% Rated	1%	90%
		Delay	<i>Low Volt Trip Dly</i>	0.0 – 60.0 Seconds	0.1 Second	3.0 Second
#43 Over Voltage	Motor energized	Enable	<i>Hi Volt Trip</i>	{On, Off}	N/A	On
		Threshold	<i>Hi Volt Level</i>	101 – 120 %Rated	1 %	110%
		Delay	<i>Hi Volt Trp Dly</i>	0.0 – 60.0 Seconds	0.1 Second	3.0 Second
#61 Mains Loss	When start is attempted	Threshold	Not User Settable	80 volts	N/A	N/A
#42 Mains Low	When start is attempted	Threshold	Not User Settable	80 volts	N/A	N/A
#43 Mains High	When start is attempted	Threshold	Not User Settable	800 volts	N/A	N/A

November 2006

Appendix C — Ratings, Cooling and Power Losses for a Line Connected Motor

Horsepower and kW Ratings

Standard Duty Ratings

Table C-1: 15 Second Ramp, 4 Starts per Hour, 300% Current Limit @ 40°C

Max. Current	Three-Phase Motors											Catalog Number
	kW Rating (50 Hz)			hp Rating (60 Hz)								
	230V	380 – 400V	440V	200V		230V		460V		575 – 690V		
1.0SF				1.15SF	1.0SF	1.15SF	1.0SF	1.15SF	1.0SF	1.15SF		
Frame Size N												
37	10	18.5	18.5	10	10	10	10	25	20	30	30	S811N37xxx
66	18.5	30	37	20	15	20	20	50	40	60	50	S811N66xxx
Frame Size R												
105	30	55	59	30	25	40	30	75	60	100	75	S811R10xxx
135	40	63	80	40	30	50	40	100	75	125	100	S811R13xxx
Frame Size T												
180	51	90	110	60	50	60	60	150	125	150	150	S811T18xxx
240	75	110	147	75	60	75	75	200	150	200	200	S811T24xxx
304	90	160	185	100	75	100	100	250	200	300	250	S811T30xxx
Frame Size U												
360	110	185	220	125	100	150	125	300	250	350	300	S811U36xxx
420	129	220	257	150	125	175	150	350	300	450	350	S811U42xxx
500	150	257	300	150	150	200	150	400	350	500	450	S811U50xxx ^②
Frame Size V												
360	110	185	220	125	100	150	125	300	250	350	300	S811V36xxx
420	129	220	257	150	125	175	150	350	300	450	350	S811V42xxx
500	150	257	300	150	150	200	150	400	350	500	450	S811V50xxx
650	200	355	425	250	200	250	200	500	450	600	500	S811V65xxx
720	220	400	450	—	—	300	250	600	500	700	600	S811V72xxx
850	257	475	500	—	—	350	300	700	600	900	700	S811V85xxx
1000	277	525	50	—	—	400	350	800	700	900	800	S811V10xxx ^①

^① See Application Notes, Appendix E.

^② 500A rating does not have IEC certification.

Table C-2: 25 Second Ramp, 4 Starts per Hour, 300% Current Limit @ 40°C

Max. Current	Three-Phase Motors											Catalog Number
	kW Rating (50 Hz)			hp Rating (60 Hz)								
	230V	380 – 400V	440V	200V		230V		460V		575 – 690V		
				1.0SF	1.15SF	1.0SF	1.15SF	1.0SF	1.15SF	1.0SF	1.15SF	
Frame Size N												
34	9	15	18.5	10	7-1/2	10	10	25	20	30	25	S811N37xxx
63	15	30	33	20	15	20	20	40	40	60	50	S811N66xxx
Frame Size R												
96	25	45	55	30	25	30	30	75	60	75	75	S811R10xxx
120	33	63	63	40	30	40	40	75	75	100	100	S811R13xxx
Frame Size T												
150	45	80	90	50	40	50	50	100	100	150	125	S811T18xxx
215	63	110	132	60	60	75	60	150	150	200	150	S811T24xxx
278	80	147	160	75	75	100	75	200	200	250	250	S811T30xxx
Frame Size U												
320	90	160	185	100	75	125	100	250	200	300	250	S811U36xxx
380	110	200	220	125	100	150	125	300	250	350	300	S811U42xxx
460	140	250	280	150	125	150	150	350	300	450	400	S811U50xxx ^②
Frame Size V												
320	90	160	185	100	75	125	100	250	200	300	250	S811V36xxx
380	110	200	220	125	100	150	125	300	250	350	300	S811V42xxx
460	140	250	280	150	125	150	150	350	300	450	400	S811V50xxx
610	185	315	375	250	150	200	200	500	450	600	500	S811V65xxx
680	200	375	445	—	200	250	200	600	500	700	600	S811V72xxx
810	250	450	500	—	—	300	300	700	600	900	700	S811V85xxx
890	290	510	560	—	—	400	350	700	600	900	700	S811V10xxx ^①

① See Application Notes, **Appendix E**.

② 500A rating does not have IEC certification.

November 2006

Table C-3: 15 Second Ramp, 4 Starts per Hour, 300% Current Limit @ 50°C

Max. Current	Three-Phase Motors											Catalog Number
	kW Rating (50 Hz)			hp Rating (60 Hz)								
	230V	380 – 400V	440V	200V		230V		460V		575 – 690V		
				1.0SF	1.15SF	1.0SF	1.15SF	1.0SF	1.15SF	1.0SF	1.15SF	
Frame Size N												
34	9	15	18.5	10	7-1/2	10	10	25	20	30	25	S811N37xxx
63	15	30	33	20	15	20	20	40	40	60	50	S811N66xxx
Frame Size R												
96	25	45	55	30	25	30	30	75	60	75	75	S811R10xxx
120	33	63	63	40	30	40	40	75	75	100	100	S811R13xxx
Frame Size T												
150	45	80	90	50	40	50	50	100	100	150	125	S811T18xxx
215	63	110	132	60	60	75	60	150	150	200	150	S811T24xxx
278	80	147	160	75	75	100	75	200	200	250	250	S811T30xxx
Frame Size U												
320	90	160	185	100	75	125	100	250	200	300	250	S811U36xxx
380	110	200	220	125	100	150	125	300	250	350	300	S811U42xxx
460	140	250	280	150	125	150	150	350	300	450	400	S811U50xxx ②
Frame Size V												
320	90	160	185	100	75	125	100	250	200	300	250	S811V36xxx
380	110	200	220	125	100	150	125	300	250	350	300	S811V42xxx
460	140	250	280	150	125	150	150	350	300	450	400	S811V50xxx
610	185	315	375	250	150	200	200	500	450	600	500	S811V65xxx
680	200	375	445	—	200	250	200	600	500	700	600	S811V72xxx
830	257	450	500	—	—	300	300	700	600	900	700	S811V85xxx
960	302	510	540	—	—	350	300	800	700	900	800	S811V10xxx ①

① See Application Notes, **Appendix E**.

② 500A rating does not have IEC certification.

Table C-4: 50 Second Ramp, 2 Starts per Hour, 300% Current Limit @ 50°C

Max. Current	Three-Phase Motors											Catalog Number
	kW Rating (50 Hz)			hp Rating (60 Hz)								
	230V	380 – 400V	440V	200V		230V		460V		575 – 690V		
				1.0SF	1.15SF	1.0SF	1.15SF	1.0SF	1.15SF	1.0SF	1.15SF	
Frame Size N												
21	5.5	10	11	5	5	5	5	15	10	15	15	S811N37xxx
42	11	18.5	22	10	10	15	10	30	25	40	30	S811N66xxx
Frame Size R												
60	15	30	33	15	15	20	15	40	40	50	50	S811R10xxx
80	22	40	45	25	20	30	25	60	50	75	60	S811R13xxx
Frame Size T												
115	33	59	63	30	30	40	30	75	75	100	100	S811T18xxx
150	45	80	90	50	40	50	50	100	100	150	125	S811T24xxx
192	55	100	110	60	50	60	60	150	125	200	150	S811T30xxx
Frame Size U												
280	80	150	160	75	75	100	75	200	200	250	250	S811U36xxx
340	110	180	200	100	100	125	100	250	200	350	300	S811U42xxx
380	110	200	220	125	100	150	125	300	250	350	300	S811U50xxx ②
Frame Size V												
280	80	150	160	75	75	100	75	200	200	250	250	S811V36xxx
340	110	180	200	100	100	125	100	250	200	350	300	S811V42xxx
380	110	200	220	125	100	150	125	300	250	350	300	S811V50xxx
420	129	220	257	150	125	150	150	350	300	450	350	S811V65xxx
480	147	257	295	150	150	200	150	400	350	500	450	S811V72xxx
590	180	315	375	200	150	200	200	500	400	600	500	S811V85xxx
650	205	370	415	250	200	250	200	500	450	600	500	S811V10xxx ①

① See Application Notes, **Appendix E**.

② 500A rating does not have IEC certification.

November 2006

Table C-5: 15 Second Ramp, 4 Starts per Hour, 450% Current Limit @ 40°C

Max. Current	Three-Phase Motors											Catalog Number
	kW Rating (50 Hz)			hp Rating (60 Hz)								
	230V	380 – 400V	440V	200V		230V		460V		575 – 690V		
				1.0SF	1.15SF	1.0SF	1.15SF	1.0SF	1.15SF	1.0SF	1.15SF	
Frame Size N												
29	7.5	12.5	15	7-1/2	7-1/2	10	7-1/2	20	15	25	20	S811N37xxx
49	12.5	22	25	15	10	15	15	30	30	40	40	S811N66xxx
Frame Size R												
73	18.5	37	40	20	20	25	20	50	40	60	60	S811R10xxx
94	25	45	55	30	25	30	30	60	60	75	75	S811R13xxx
Frame Size T												
155	45	80	90	50	40	60	50	100	100	150	125	S811T18xxx
219	63	110	132	60	60	75	60	150	150	200	150	S811T24xxx
280	80	150	160	75	75	100	75	200	200	250	250	S811T30xxx
Frame Size U												
345	100	185	200	100	100	125	100	250	200	350	300	S811U36xxx
405	110	200	250	125	100	150	125	300	250	400	350	S811U42xxx
Frame Size V												
345	100	185	200	100	100	125	100	250	200	350	300	S811V36xxx
405	110	200	250	125	100	150	125	300	250	400	350	S811V42xxx
465	140	250	280	150	125	150	150	350	300	450	400	S811V50xxx
530	160	280	335	150	150	200	150	450	350	500	450	S811V65xxx
590	180	315	375	200	150	—	200	500	400	600	500	S811V72xxx
651	200	355	425	—	—	—	—	600	450	700	600	S811V85xxx
754	220	400	465	—	—	—	—	600	500	800	700	S811V10xxx ^①

^① See Application Notes, **Appendix E**.

Table C-6: 30 Second Ramp, 4 Starts per Hour, 450% Current Limit @ 40°C

Max. Current	Three-Phase Motors											Catalog Number
	kW Rating (50 Hz)			hp Rating (60 Hz)								
	230V	380 – 400V	440V	200V		230V		460V		575 – 690V		
				1.0SF	1.15SF	1.0SF	1.15SF	1.0SF	1.15SF	1.0SF	1.15SF	
Frame Size N												
21	5.5	10	12.5	5	5	5	5	15	10	15	15	S811N37xxx
40	11	18.5	22	10	10	10	10	30	25	30	30	S811N66xxx
Frame Size R												
55	15	25	30	15	15	20	15	40	30	50	40	S811R10xxx
75	22	37	45	20	20	25	20	50	50	60	60	S811R13xxx
Frame Size T												
151	45	80	90	50	40	50	50	100	100	150	125	S811T18xxx
215	63	110	132	60	60	75	60	150	150	200	150	S811T24xxx
264	80	140	160	75	75	100	75	200	150	250	200	S811T30xxx
Frame Size U												
300	90	160	185	100	75	100	100	200	200	300	250	S811U36xxx
340	100	180	200	100	100	125	100	250	200	350	300	S811U42xxx
Frame Size V												
300	90	160	185	100	75	100	100	200	200	300	250	S811V36xxx
340	100	180	200	100	100	125	100	250	200	350	300	S811V42xxx
380	110	200	220	125	100	150	125	300	250	350	300	S811V50xxx
420	129	220	257	150	125	150	150	350	300	450	350	S811V65xxx
460	140	250	280	150	125	150	150	350	300	450	400	S811V72xxx
500	150	257	300	150	150	200	150	400	350	500	450	S811V85xxx
560	160	277	325	200	150	250	200	500	400	600	500	S811V10xxx ^①

^① See Application Notes, **Appendix E**.

November 2006

Severe Duty Ratings

Table C-7: > 30 Second Ramp, > 4 Starts per Hour or >300% Current Limit

Max. Current	Three-Phase Motors											Catalog Number
	kW Rating (50 Hz)			hp Rating (60 Hz)								
	230V	380 – 400V	440V	200V		230V		460V		575 – 690V		
				1.0SF	1.15SF	1.0SF	1.15SF	1.0SF	1.15SF	1.0SF	1.15SF	
Frame Size N												
22	5.5	10	11	5	5	7-1/2	5	15	10	20	15	S811N37xxx
42	11	18.5	22	10	10	15	10	30	25	40	30	S811N66xxx
Frame Size R												
65	15	30	33	15	15	20	15	50	40	50	50	S811R10xxx
80	22	40	45	25	20	30	25	60	50	75	60	S811R13xxx
Frame Size T												
115	33	59	63	30	30	40	30	75	75	100	100	S811T18xxx
150	45	80	90	50	40	50	50	100	100	150	125	S811T24xxx
192	55	100	110	60	50	75	60	150	125	200	150	S811T30xxx
Frame Size U												
240	75	110	147	75	60	75	75	200	150	200	200	S811U36xxx
305	90	160	185	100	75	100	100	250	200	300	250	S811U42xxx
Frame Size V												
240	75	110	147	75	60	75	75	200	150	200	200	S811V36xxx
305	90	160	185	100	75	100	100	250	200	300	250	S811V42xxx
365	110	185	220	125	100	150	125	300	250	350	300	S811V50xxx
420	129	220	257	150	125	150	150	350	300	450	350	S811V65xxx
480	147	257	295	150	150	200	150	400	350	500	450	S811V72xxx
525	160	280	335	150	150	200	150	450	350	500	450	S811V85xxx
575	172	303	370	200	150	250	200	500	450	600	500	S811V10xxx ^①

^① See Application Notes, Appendix E.

Severe Duty Ratings are defined as any combination of parameters that exceed the Standard Duty Ratings where the ramp time is over 30 seconds, the number of starts per hour exceeds 4, or the current limit set is over 300%. Example: 35-Second Ramp, 5 Starts per Hour, 350% Current Limit @ 40°C Ambient.

Cooling

Microcontroller controlled fans are used to cool the *IT*. Soft Starter. The fans are turned on when the temperature of any of the thermal sensors exceeds preset value. Once the fans are started, they will not go off until the temperature goes below the off set point for 10 minutes.

The fans will also be turned on whenever the *IT*. is started, stopped or jogged. The fans will remain on for 10 minutes to assure the SCRs are adequately cooled prior to the next start.

If a temperature is sensed above a second preset level, a Pole Over-Temperature Fault will occur. This fault cannot be reset until the temperature returns to a safe level.

Note: The fans will only operate if 24V DC is applied to the + and – terminals. Cycling power during the 10 minute timeout after a start, stop or jog will reset the fans to off.

Power Losses

The following table lists the maximum power loss for each *IT*. Soft Starter when it is operating in the across-the-line mode with its bypass contactor pulled in. These losses should be used in conjunction with the losses of another cabinet mounted device to determine the enclosure size and any cooling requirements.

Table C-8: Maximum Power Loss

Frame Size	Catalog Number	Current Range for a Line Connection	Across-the-Line-Losses (Watts)
N	S811N37xxx	11 – 37	30
	S811N66xxx	20 – 66	33
R	S811R10xxx	32 – 105	47
	S811R13xxx	42 – 135	55
T	S811T18xxx	56 – 180	37
	S811T24xxx	75 – 240	40
	S811T30xxx	95 – 304	45
U	S811U36xxx	112 – 360	76
	S811U42xxx	131 – 420	92
	S811U50xxx	156 – 500 ^①	116
V	S811V36xxx	112 – 360	56
	S811V42xxx	131 – 420	64
	S811V50xxx	156 – 500	78
	S811V65xxx	203 – 650	109
	S811V72xxx	225 – 720	127
	S811V85xxx	265 – 850	164
	S811V10xxx	310 – 1000	215

^① 500A rating does not have IEC certification.

November 2006

Appendix D — Ratings, Cooling and Power Losses for an Inside-the-Delta Connected Motor

Horsepower and kW Ratings

Inside-the-Delta Standard Duty Ratings

Table D-1: 15 Second Ramp, 4 Starts per Hour, 300% Current Limit @ 40°C Ambient

Max. Continuous Motor Line Current	Three-Phase Motor											Catalog Number
	kW Rating (50 Hertz)			hp Rating (60 Hertz)								
	230V	380 – 400V	440V	200V		230V		460V		575V		
				1.0SF	1.15SF	1.0SF	1.15SF	1.0SF	1.15SF	1.0SF	1.15SF	
Frame Size N												
65	10	18.5	18.5	15	15	15	15	40	30	50	50	S811N37xxD S811N66xxD
114	18.5	30	37	30	25	30	30	75	60	100	75	
Frame Size R												
182	30	55	59	50	40	60	50	125	100	150	125	S811R10xxD S811R13xxD
234	40	63	80	60	50	75	60	150	125	200	150	
Frame Size T												
311	51	90	110	100	75	100	100	250	200	250	250	S811T18xxD S811T24xxD S811T30xxD
415	75	110	147	125	100	125	125	300	250	300	300	
526	90	160	185	150	125	150	150	400	300	400	400	
Frame Size U												
623	110	185	220	200	150	250	200	450	400	550	450	S811U36xxD S811U42xxD S811U50xxD ^①
727	129	220	257	250	200	300	250	550	450	700	550	
865	150	257	300	250	250	300	250	600	550	750	700	
Frame Size V												
623	110	185	220	200	150	250	200	450	400	550	450	S811V36xxD S811V42xxD S811V50xxD S811V65xxD S811V72xxD S811V85xxD S811V10xxD
727	129	220	257	250	200	300	250	550	450	700	550	
865	150	257	300	250	250	300	250	600	550	750	700	
1125	200	355	425	400	300	400	300	750	700	900	750	
1246	—	—	—	—	—	—	—	—	—	—	—	
1471	—	—	—	—	—	—	—	—	—	—	—	
—	—	—	—	—	—	—	—	—	—	—	—	

^① Does not have IEC certification.

Table D-2: 25 Second Ramp, 4 Starts per Hour, 300% Current Limit @ 40°C Ambient

Max. Continuous Motor Line Current	Three-Phase Motor										Catalog Number	
	kW Rating (50 Hertz)			hp Rating (60 Hertz)								
	230V	380 – 400V	440V	200V		230V		460V		575V		
				1.0SF	1.15SF	1.0SF	1.15SF	1.0SF	1.15SF	1.0SF		1.15SF

Frame Size N

58	9	15	18.5	15	10	15	15	40	30	50	40	S811N37xxD S811N66xxD
108	15	30	33	30	25	30	30	60	60	100	75	

Frame Size R

164	25	45	55	50	40	50	50	125	100	125	125	S811R10xxD S811R13xxD
206	33	63	63	60	50	60	50	125	125	150	150	

Frame Size T

257	45	80	90	75	60	75	60	150	150	250	200	S811T18xxD S811T24xxD S811T30xxD
365	63	110	132	100	100	125	100	250	250	300	250	
477	80	147	160	125	125	150	125	300	300	400	400	

Frame Size U

554	90	160	185	150	125	200	150	400	300	450	400	S811U36xxD S811U42xxD S811U50xxD ^①
646	110	200	220	200	150	250	200	500	400	550	450	
796	140	250	280	250	200	250	250	550	500	700	600	

Frame Size V

554	90	160	185	150	125	200	150	400	300	450	400	S811V36xxD S811V42xxD S811V50xxD S811V65xxD S811V72xxD S811V85xxD S811V10xxD
646	110	200	220	200	150	250	200	500	400	550	450	
796	140	250	280	250	200	250	250	550	500	700	600	
1055	185	315	375	400	250	300	300	800	700	900	750	
1176	200	375	445	—	300	400	300	900	800	900	900	
1358	—	—	—	—	—	—	—	—	—	—	—	
—	—	—	—	—	—	—	—	—	—	—	—	
—	—	—	—	—	—	—	—	—	—	—	—	

^① Does not have IEC certification.

November 2006

Table D-3: 15 Second Ramp, 4 Starts per Hour, 300% Current Limit @ 50°C Ambient

Max. Continuous Motor Line Current	Three-Phase Motor											Catalog Number
	kW Rating (50 Hertz)			hp Rating (60 Hertz)								
	230V	380 – 400V	440V	200V		230V		460V		575V		
				1.0SF	1.15SF	1.0SF	1.15SF	1.0SF	1.15SF	1.0SF	1.15SF	
Frame Size N												
58	9	15	18.5	15	10	15	15	40	30	50	40	S811N37xxD
108	15	30	33	30	25	30	30	60	60	100	75	
Frame Size R												
164	25	45	55	50	40	50	50	125	100	125	125	S811R10xxD
206	33	63	63	60	50	60	60	125	125	150	150	
Frame Size T												
257	45	80	90	75	60	75	75	150	150	250	200	S811T18xxD
365	63	110	132	100	100	125	100	250	250	300	250	
477	80	147	160	125	125	150	125	300	300	400	400	S811T30xxD
Frame Size U												
554	90	160	185	150	125	200	150	400	300	450	400	S811U36xxD
646	110	200	220	200	150	250	200	450	400	550	450	
796	140	250	280	250	200	250	250	550	450	700	600	S811U50xxD ^①
Frame Size V												
554	90	160	185	150	125	200	150	400	300	450	400	S811V36xxD
646	110	200	220	200	150	250	200	450	400	550	450	
796	140	250	280	250	200	250	250	550	450	700	600	S811V50xxD
1055	185	315	375	400	250	300	300	750	700	900	750	S811V65xxD
1176	200	375	445	—	—	—	—	—	—	—	—	S811V72xxD
1358	257	450	500	—	—	—	—	—	—	—	—	S811V85xxD
—	—	—	—	—	—	—	—	—	—	—	—	S811V10xxD

^① Does not have IEC certification.

Table D-4: 50 Second Ramp, 2 Starts per Hour, 300% Current Limit @ 50°C Ambient

Max. Continuous Motor Line Current	Three-Phase Motor											Catalog Number
	kW Rating (50 Hertz)			hp Rating (60 Hertz)								
	230V	380 – 400V	440V	200V		230V		460V		575V		
				1.0SF	1.15SF	1.0SF	1.15SF	1.0SF	1.15SF	1.0SF	1.15SF	

Frame Size N

36	5.5	10	11	7-1/2	7-1/2	7-1/2	7-1/2	25	15	25	25	S811N37xxD S811N66xxD
73	11	18.5	22	15	15	25	15	50	40	60	50	

Frame Size R

103	15	30	33	25	25	30	25	60	60	75	75	S811R10xxD S811R13xxD
138	22	40	45	40	30	50	40	100	75	125	100	

Frame Size T

199	33	59	63	50	50	60	50	125	125	150	150	S811T18xxD S811T24xxD S811T30xxD
257	45	80	90	75	60	75	75	150	150	250	200	
324	55	100	110	100	75	100	100	250	200	300	250	

Frame Size U

485	80	150	160	125	125	150	125	300	300	400	400	S811U36xxD S811U42xxD S811U50xxD ^①
580	100	180	200	150	150	200	150	400	300	550	450	
646	110	200	220	200	150	250	200	450	400	550	450	

Frame Size V

485	80	150	160	125	125	150	125	300	300	400	400	S811V36xxD S811V42xxD S811V50xxD S811V65xxD S811V72xxD S811V85xxD S811V10xxD
580	100	180	200	150	150	200	150	400	300	550	450	
646	110	200	220	200	150	250	200	450	400	550	450	
727	129	220	257	250	200	250	250	550	500	700	550	
816	147	257	295	250	250	300	250	600	550	750	700	
1021	180	315	375	300	250	300	300	750	600	900	750	
—	—	—	—	—	—	—	—	—	—	—	—	
—	—	—	—	—	—	—	—	—	—	—	—	

^① Does not have IEC certification.

November 2006

Table D-5: 15 Second Ramp, 4 Starts per Hour, 450% Current Limit @ 40°C Ambient

Max. Continuous Motor Line Current	Three-Phase Motor											Catalog Number
	kW Rating (50 Hertz)			hp Rating (60 Hertz)								
	230V	380 – 400V	440V	200V		230V		460V		575V		
1.0SF				1.15SF	1.0SF	1.15SF	1.0SF	1.15SF	1.0SF	1.15SF		

Frame Size N

47	7.5	12.5	15	10	10	15	10	30	25	40	30	S811N37xxD
83	12.5	22	25	25	15	25	25	50	50	60	60	S811N66xxD

Frame Size R

126	18.5	37	40	30	30	40	30	75	60	100	100	S811R10xxD
162	25	45	55	50	40	50	50	100	100	125	125	S811R13xxD

Frame Size T

266	45	80	90	75	60	100	75	150	150	250	200	S811T18xxD
379	63	110	132	100	100	125	100	250	250	300	250	S811T24xxD
485	80	150	160	125	125	150	125	300	300	400	400	S811T30xxD

Frame Size U

580	100	185	200	150	150	200	150	400	300	550	450	S811U36xxD
695	110	200	250	200	150	250	200	450	400	600	550	S811U42xxD
798	140	250	280	250	200	250	250	550	450	700	600	S811U50xxD ^①

Frame Size V

580	100	185	200	150	150	200	150	400	300	550	450	S811V36xxD
695	110	200	250	200	150	250	200	450	400	600	550	S811V42xxD
798	140	250	280	250	200	250	250	550	450	700	600	S811V50xxD
908	160	280	335	250	250	300	250	700	550	750	700	S811V65xxD
1021	—	—	—	—	—	—	—	—	—	—	—	S811V72xxD
1125	—	—	—	—	—	—	—	—	—	—	—	S811V85xxD

^① Does not have IEC certification.

Table D-6: 30 Second Ramp, 4 Starts per Hour, 450% Current Limit @ 40°C Ambient

Max. Continuous Motor Line Current	Three-Phase Motor											Catalog Number
	kW Rating (50 Hertz)			hp Rating (60 Hertz)								
	230V	380 – 400V	440V	200V		230V		460V		575V		
1.0SF				1.15SF	1.0SF	1.15SF	1.0SF	1.15SF	1.0SF	1.15SF		

Frame Size N

36	5.5	10	12.5	7-1/2	7-1/2	7-1/2	7-1/2	25	15	25	25	S811N37xxD S811N66xxD
69	11	18.5	22	15	15	15	15	50	40	50	50	

Frame Size R

96	15	25	30	25	25	30	25	60	50	75	60	S811R10xxD S811R13xxD
130	22	37	45	30	30	40	30	75	75	100	100	

Frame Size T

257	45	80	90	75	60	75	75	150	150	250	200	S811T18xxD S811T24xxD S811T30xxD
365	63	110	132	100	100	125	100	250	250	300	250	
448	80	140	160	125	125	150	125	300	250	400	300	

Frame Size U

503	90	160	185	150	125	150	150	300	300	450	400	S811U36xxD S811U42xxD S811U50xxD ^①
580	100	180	200	150	150	200	150	400	300	550	450	
646	110	200	220	200	150	250	200	450	400	550	450	

Frame Size V

503	90	160	185	150	125	150	150	300	300	450	400	S811V36xxD S811V42xxD S811V50xxD S811V65xxD S811V72xxD S811V85xxD
580	100	180	200	150	150	200	150	400	300	550	450	
646	110	200	220	200	150	250	200	450	400	550	450	
727	129	220	257	250	200	250	250	550	450	700	550	
796	—	—	—	—	—	—	—	—	—	—	—	
865	—	—	—	—	—	—	—	—	—	—	—	

^① Does not have IEC certification.

November 2006

Inside-the-Delta Severe Duty Ratings

Table D-7: Severe Duty Inside-the-Delta Ratings

Max. Continuous Motor Line Current	Three-Phase Motor											Catalog Number
	kW Rating (50 Hertz)			hp Rating (60 Hertz)								
	230V	380 – 400V	440V	200V		230V		460V		575V		
				1.0SF	1.15SF	1.0SF	1.15SF	1.0SF	1.15SF	1.0SF	1.15SF	
Frame Size N												
39	5.5	10	11	7-1/2	7-1/2	10	7-1/2	25	15	30	25	S811N37xxD S811N66xxD
73	11	18.5	22	15	15	25	15	50	40	60	50	
Frame Size R												
111	15	30	33	25	25	30	25	75	60	75	75	S811R10xxD S811R13xxD
138	22	40	45	40	30	50	40	100	75	120	100	
Frame Size T												
199	33	59	63	50	50	60	50	125	125	150	150	S811T18xxD S811T24xxD S811T30xxD
257	45	80	90	75	60	75	75	150	150	250	200	
324	55	100	110	100	75	100	100	250	200	300	250	
Frame Size U												
415	75	110	147	125	100	125	125	300	250	300	300	S811U36xxD S811U42xxD S811U50xxD ^①
526	90	160	185	150	120	150	150	400	300	450	400	
623	110	185	220	200	150	250	200	450	400	550	450	
Frame Size V												
415	75	110	147	125	100	125	125	300	250	300	300	S811V36xxD S811V42xxD S811V50xxD S811V65xxD S811V72xxD S811V85xxD S811V10xxD
526	90	160	185	150	120	150	150	400	300	450	400	
623	110	185	220	200	150	250	200	450	400	550	450	
727	129	220	257	250	200	250	250	550	450	700	550	
816	147	257	295	250	250	300	250	600	550	750	700	
908	160	280	335	250	250	300	250	700	550	750	700	
—	—	—	—	—	—	—	—	—	—	—	—	
—	—	—	—	—	—	—	—	—	—	—	—	

① Does not have IEC certification.

Severe Duty Ratings are defined as any combination of parameters that exceed the Standard Duty Ratings where the ramp time is over 30 seconds, the number of starts per hour exceeds 4, or the current limit set is over 300%. Example: 35-Second Ramp, 5 Starts per Hour, 350% Current Limit @ 40°C Ambient.

Cooling

Microcontroller controlled fans are used to cool the *IT*. Soft Starter. The fans are turned on when the temperature of any of the thermal sensors exceeds preset value. Once the fans are started, they will not go off until the temperature goes below the off set point for 10 minutes.

The fans will also be turned on whenever the *IT*. is started, stopped or jogged. The fans will remain on for 10 minutes to assure the SCRs are adequately cooled prior to the next start.

If a temperature is sensed above a second preset level, a Pole Over-Temperature Fault will occur. This fault cannot be reset until the temperature returns to a safe level.

Note: The fans will only operate if 24V DC is applied to the + and – terminals. Cycling power during the 10 minute timeout after a start, stop or jog will reset the fans to off.

Power Losses

The following table lists the maximum power loss for each *IT*. Soft Starter when it is operating in the across-the-line mode with its bypass contactor pulled in. These losses should be used in conjunction with the losses of another cabinet mounted device to determine the enclosure size and any cooling requirements.

Table D-8: Maximum Power Loss

Frame Size	Catalog Number	Current Range for an Inside-the-Delta Connection	Across-the-Line-Losses (Watts)
N	S811N37xxD	19 – 65	30
	S811N66xxD	35 – 114	33
R	S811R10xxD	55 – 182	47
	S811R13xxD	73 – 234	55
T	S811T18xxD	97 – 311	37
	S811T24xxD	130 – 415	40
	S811T30xxD	164 – 526	45
U	S811U36xxD	193 – 623	76
	S811U42xxD	227 – 727	92
	S811U50xxD	270 – 865	116
V	S811V36xxD	193 – 623	56
	S811V42xxD	227 – 727	64
	S811V50xxD	270 – 865	78
	S811V65xxD	352 – 1125	109
	S811V72xxD	389 – 1246	127
	S811V85xxD	458 – 1471	164

November 2006

Appendix E — Motor/Application Considerations

Using MOVs

Most utility power systems experience periodic transient voltages. Line or power factor correction capacitor switching, nearby lightning strikes, utility supply faults, or a user starting or shutting down a large load such as a motor can cause these voltages. The *IT* Soft Starter has been designed to handle transient voltages of up to 4 kV lasting up to 20 μ S.

If transient voltages of greater magnitude or longer duration than the standard withstand capability are expected, a protective module must be installed. The protective module contains metal oxide varistors (MOVs). MOVs are devices that remain in a passive state until a transient voltage occurs. Under the transient condition, the MOV turns on and holds the peak line voltage down to a level less than the *IT* transient voltage rating. When the transient clears, the MOV returns to a passive state.

Eaton offers two MOV option kits:

Table E-1: MOV Kit Options

Catalog Number	Description
EMS38	600V (max) MOV for S811N and S811R Soft Start (side mounted)
EMS39	600V (max) MOV for S811T and S811V Soft Start
EMS41	690V (max) MOV for S811T, V35 and S811V, V35

The EMS38 is panel mounted, while the EMS39 and EMS41 are mounted directly on the *IT* Soft Starter.

In situations where an MOV must be used, the installer may choose to apply a different transient absorption device, but it must be equivalent to the EMS38, EMS39 or EMS41. These MOVs may also be used on the load side of the soft starter where long cables connect the motor to the soft starter or where the cables are located outdoors.

Squirrel Cage Motor

This is the most common application.

The motor is configured with three motor leads available.

In this case, wire the motor to the soft starter with one lead per phase, observing proper phase rotation. An in-sight disconnect means should be installed, per code requirements.

Wye-Delta Motor

The wye-delta motor is a traditional way of achieving a reduced voltage start using regular contactors and starters. In this method, the motor is constructed with all six leads brought out to connect the unit in a wye configuration. This allows about 58% of the current (33% starting torque) to be applied during start-up. A timer is used to control the circuit and switch to the delta configuration as the unit approaches full speed.

In this case, wire the six-lead motor in a standard delta configuration. The soft starter is then used to control the voltage and motor torque without the need for additional circuitry. An in-sight disconnect means should be installed, per local code. The **IT**. Soft Starter must be wired into the three-phase line feeding the three main motor input leads as would be done for normal across-the-line starting. **It must not be wired internally between motor windings in an inside-the-delta configuration. If an inside-the-delta starting configuration is desired, please contact Eaton for details about our inside-the-delta soft starters, designated S811xxxxD.**

Part Winding Motor

The part winding motor is another design created to help achieve a soft start to the load. A part winding motor is constructed of two separate (but parallel) windings. When using a traditional starter, the first winding would receive full voltage. This winding supplies as much as 400% of the motors FLA; about 45% starting torque in a delta configuration for motor start-up. After a timed delay, full voltage is applied to the second winding. The second winding acts in parallel with the first to provide for normal running current. Part winding motors are available in both a wye and delta configuration, dependent upon the manufacturer. Refer to the motor nameplate for the correct wiring information. In this case, wire the two windings in parallel. The soft starter is then used to control the current applied to the motor. An in-sight disconnect means should be installed, per code requirements.

Dual Voltage Motor

A dual voltage motor should be wired into the appropriate configuration for the line voltage it is being applied to. Refer to the motor nameplate for the correct wiring information. The soft starter must be selected for the appropriate line voltage.

Multi-Speed Motor

Some motors have multiple windings to allow operation at different base speeds. The multiple speeds are sometimes utilized for soft starting and other times for a process requirement of the machine to which it is attached. If only one speed is required, the motor should be wired for that speed. If multiple speeds are required, the appropriate contactors will need to be connected to the output of the Soft Starter. The contactors must be in the selected speed position before the soft starter is started. The motor must be stopped and the soft starter turned off before the speed selection contactors are changed.

November 2006



Other Winding Configurations

Motors with other winding configurations, designed for specific characteristics, should be wired in a fashion consistent with their intended use. The motor nameplate contains information on the available configurations. The motor winding configuration chosen must be appropriate for the available line voltage. The soft starter must also be selected on the basis of the configuration chosen.

Power Factor Correction Capacitors

Power factor correction capacitors should be installed on the line side of the soft starter. It is recommended that at least 10 feet of cable be between the capacitor and the soft starter. The power factor correction capacitors can be switched with a separate contactor. NEMA ICS2-1988 Part 2-210.81.01 provides recommendations for when a separate contactor should be used to switch the power factor correction capacitor including high inertia loads, reversing motors, frequently jogged motors and multi-speed motors.

It is not recommended that the power factor correction capacitors be used on the load side of the soft starter. If used on the load side, the overload relay will measure the combination of capacitor and motor current causing the overload relay to not function correctly.

 Caution	 Attention	 Precaución
Never megger a motor while it is connected to the <i>IT</i> . Soft Starter. Disconnect the leads at the <i>IT</i> . Soft Starter before meggering the motor.	Ne jamais régler un moteur alors qu'il est branché au démarreur progressif <i>IT</i> . Débrancher les fils au démarreur progressif <i>IT</i> . Avant de régler le moteur.	Nunca efectúe pruebas del motor con un megóhmetro mientras esté conectado al arrancador Soft Starter <i>IT</i> . Desconecte los cables en el arrancador <i>IT</i> . antes de usar el megóhmetro.

November 2006

Appendix F — Special Function Options

This section covers the descriptions, identification, installation and setup of factory-installed options that are not provided with the standard S811 soft starter.

Pump Control Option

This option is intended to reduce the potential for water hammer in a centrifugal pump system by utilizing a starting and stopping algorithm developed for pump control. Upon a start command, the speed of the motor is increased, under the control of the *IT*. Soft Starter microprocessor, to achieve a gentle start. After the speed has reached its nominal value, the bypass contactors close and the pump operates as with any other starter. Upon a stop command, the bypass contactors are opened and the motor speed is decreased in a tapered manner, to gradually slow the flow until the motor is brought to a stop. The start and stop ramp times are user adjustable and are to be set for the application requirements.

The pump control option is a factory installed feature. Factory installed options are designated by the eighth character in the catalog number. Unmodified *IT*. Soft Starters have an **N** as their eighth character. *IT*. Soft Starters with the pump control option have a **P** as their eighth character, as in S811xxxP3S.

Installation

Install and wire your *IT*. Soft Starter per the instructions found in the beginning of this manual.

Setup

All pump control parameters are set via the DIM. Units configured with the pump control option can activate this feature by selecting the pump option under the DIM "Start Method" parameter.

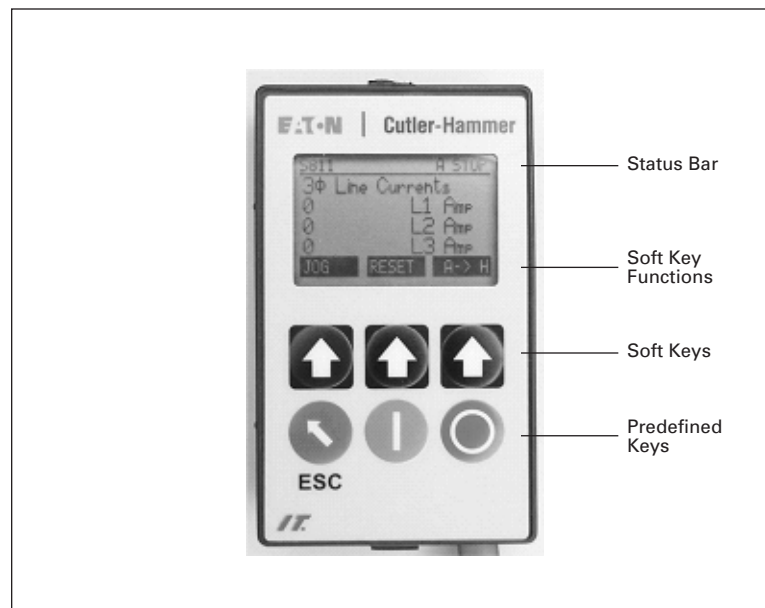

Figure F-1: *IT*. Soft Starter DIM

Adjustment

All of the adjustments to the *IT*. Soft Starter are made as noted in this user manual. The major difference between the standard *IT*. Soft Starter and one with the pump start option is the special algorithm for gentle start and stop with centrifugal flow loads to minimize the potential for water hammer.

Using the DIM, set the S811 Soft Start Configuration parameters described below:

The *Start Ramp Time* parameter adjusts the start ramp. It has a standard range of 0.5 to 180.0 seconds. The factory default is 20.0 seconds. The soft stop time is adjusted by *Pump Stop*, which has a range of 5.0 to 120.0 seconds with the factory default being 10.0 seconds. (**NOTE:** The *Stop Ramp Time* setting used in non-pump S811s has no effect on units with the Pump Control Option installed if start method is Pump Start.) These adjustments are application dependent, and should be made to minimize any surge or water hammer effects. Typically *Pump Stop* would not be set short, since the stop might not differ much from a coast-to-stop. The soft stop time adjustment may often be in the range of 30 to 40 seconds, but needs to be set appropriately for the system requirements. If reduction or elimination of water hammer is not achieved, it may be necessary to lengthen *Pump Stop* to achieve the desired result. Note that long stop times will result in greater motor heating than shorter stop times. This can affect the number of start/stop cycles allowed per hour due to the *IT*. Soft Starter or motor thermal limits.

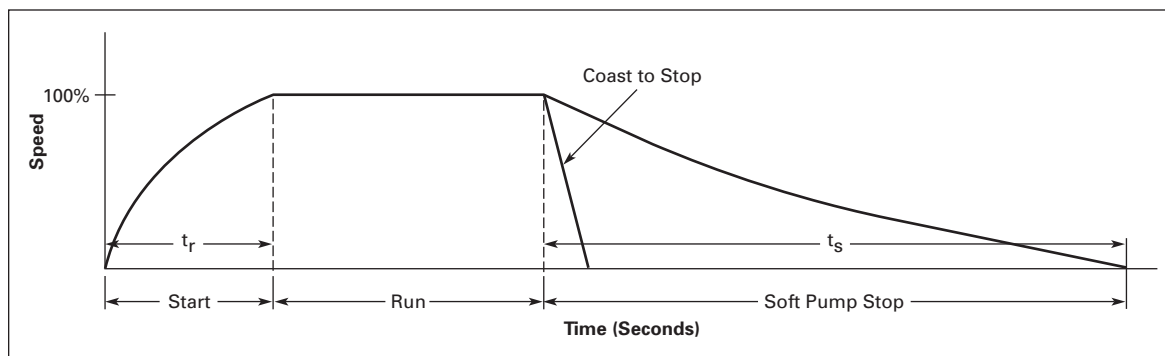

Figure F-2: Pump Start Ramp and Soft Pump Stop

Extended Ramp Option

This option allows for a longer ramp acceleration time of 0.5 to 360 seconds. The Extended Ramp option is a factory-installed option designated by the tenth character in the Catalog Number. Standard Ramp S811 *IT*. Soft Starters have an **S** as their tenth character. S811 *IT*. Soft Starters with the Extended Ramp option have an **L** as their tenth character, as in S811xxxx3**L**. Note that long ramp times will result in greater motor heating than shorter ramp times. This can affect the number of start/stop cycles allowed per hour due to the *IT*. Soft Starter or motor thermal limits.

Installation

Install and wire your *IT*. Soft Starter per the instructions found in the beginning of this manual.

Setup

Set up the soft starter per the instructions found in **Chapter 7** of this manual.

November 2006

Appendix G — User Interface — DIM

The DIM (Digital Interface Module) is a third generation microprocessor controlled graphical LCD display capable of communicating to any QCPort device that it is connected to. It has an RJ45 connection that supplies 24V and communications lines to the device. This connection is typically made to an S811 via the internal cover mounted cradle. Additional DIMs can be connected to the other Local Port connection, which is located near the terminal block. The Remote Port does not source 24V so is not an appropriate choice for the DIM.

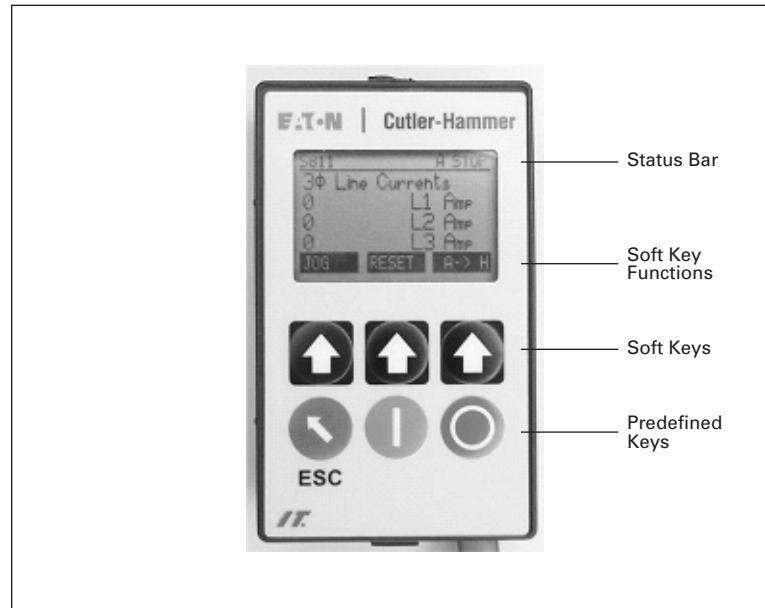

Figure G-1: DIM (Digital Interface Module)

The DIM allows a user three basic modes:

Display Mode — where the status of the system can be viewed (this is the default view on powerup).

Parameter Edit Mode — where Menus are displayed, and a user can view and change Items. The ESCape key is used to switch between the two different modes.

Fault Mode — this mode overlays the Display Mode when a fault is active. It will not supersede active Parameter Edit.

Modes of Operation

Display Mode — In this mode, the User Interface shows four things:

- The device that the UI is connected to (the S811)
- The Hand or Auto system status (H or A in the upper right)
- The status of the S811 (Running, Faulted, Stopped, At Ref)
- The 3-Phase Line Current for the S811

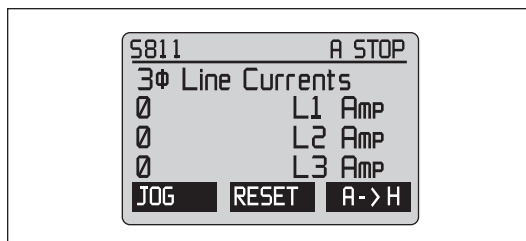

Figure G-2: Display Mode LCD

Parameter Edit Mode — In this mode, the user can navigate through the S811 Menus and Items, and potentially edit parameters if they are Read-Write. Also, multi-element Items are supported, as well as enumerated Items (items that are represented by a symbolic or textual description).

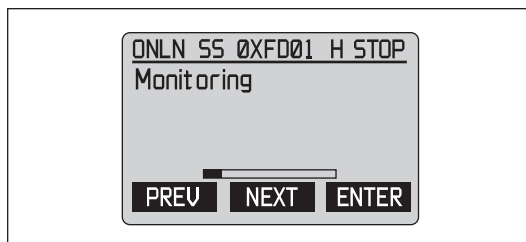

Figure G-3: Parameter Edit Mode LCD

Fault Mode — If the DIM is on the Display screen, and a fault occurs, the Display screen is replaced with a fault overlay, displaying what the fault is. This screen will go away and go back to the Display screen if the fault clears itself, or if the user presses the ESCape key.

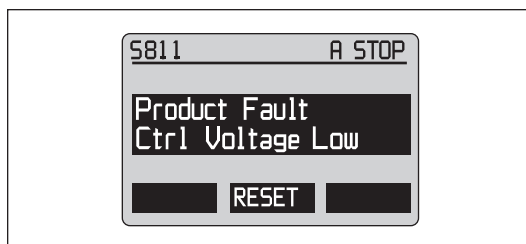

Figure G-4: Fault Mode LCD

November 2006

Button Operation

Soft Keys

The DIM has three Soft Keys that change their operation based on context. These keys typically represent Increase/Decrease/Enter, but change based on the menu that the DIM is in. The function that they represent is displayed at the bottom of the LCD Screen.

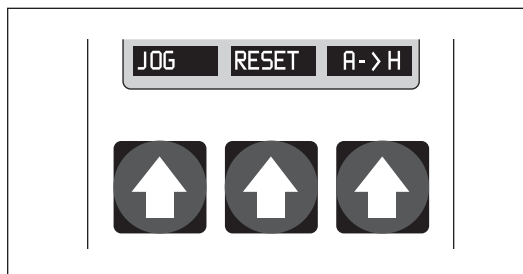

**Figure G-5: Soft Key Functions
Above Soft Keys**

On the User Display screen the DIM has the Soft Keys defined as follows:

JOG — The Jog applies a momentary Run command as the button is held down. The soft start will start ramping the frequency up to line frequency until the button is released, at which time the unit will stop, using the Load Release mode of stopping. The bypass contact does not close even when up to speed. If the unit is able to jog, the upper right Motor Control Status notification will say RUN2 during a jog.

RESET — This resets the active system fault, if the fault is not being presently asserted. The fault can be found in the Motor Control Menu and is called App Status. When the unit is not actively faulted, this will be 0. Note that Motor Control Menu/Fault Warning Queue contains the most recent 10 faults in temporal order. The DIM will reflect a faulted condition requiring a Reset fault in the upper right status box, which will flash Faulted.

A->H or H->A — This soft key switches the command from the DIM from AUTO to HAND (A->H), or from HAND to AUTO (H->A). If an On (1) or Off (0) command has been pushed on the DIM, the DIM is subsequently in HAND mode and can be switched back to AUTO using the H->A button.

Hand operation works as follows:

- If any device is commanding HAND, the S811 system is in HAND (and this is reflected as H in the upper right).
- If the system is in HAND, only devices that are in HAND can issue a Run command.
- The UI will go into HAND if a Run or Stop command is pressed.

See **Appendix A** for a Ladder Logic representation of HAND and AUTO system operation.

Other Common **Soft Keys** (used when editing parameters) are:

INC and **DEC** — Increment or Decrement the value of the parameter actively being edited.

NEXT and **PREV** — Next and Previous — go through the Menus or through the Items in the forward or reverse direction.

MORE — If the present parameter has multiple elements, the MORE key will be displayed. It will allow the element of the parameter to be selected.

EDIT — Edit the parameter being shown. Note that if a parameter is Read Only this will not be displayed. Also, if the Access Level (password) entered is not high enough to be able to change the parameter, the EDIT button will not be displayed.

SAVE — Save the value being edited at the value that is currently being displayed.

ENTER — Used to Enter into a Menu to View Items.

The following are lesser-used Soft Keys (used when editing parameters).

SELECT — Used when setting Access Level, and when doing Get Reg and Set Reg operations.

MENU — Used to get to DIM menus if an internal fault occurs.

SCAN — Used in the LCD DIM Setup menu to Scan for Devices.

GROUP and **MEMBER** — Used in the LCD DIM Setup menu to select the upper and lower byte of the ID to send an explicit command to.

SEND — Used in the LCD DIM Setup menu to send an explicit command.

Predefined Keys



Figure G-6: Predefined Keys

Escape Key — The Escape key brings the DIM out of the operation that it currently is in. At the top level, it switches the DIM between the User Display screen and the Parameter Edit screen.

1 and 0 (Start and Stop) Keys — The On (1) key sends a start command to the device that the DIM is currently connected to (the S811). The Off (0) key sends a stop command to that device. If the S811 responds to the On command, the Motor Control status notification in the upper right will reflect this by going from STOP to RUN1.

Note: **TO AVOID INADVERTENT STARTING OF THE S811, THE ON (1) BUTTON MUST BE HELD FOR MORE THAN 0.3 SECONDS TO INITIATE A START.** This amount of time is adjustable in the LCD DIM Setup menu, and is called *Run Delay*. It can be adjusted down to 0.1 seconds. **If *Run Delay* is set to 0, the RUN button is disabled for the DIM.**

November 2006

Areas of the Screen

Status Bar

The top of the screen has various areas that change with the context of the main menu area, and with the various communication conditions.

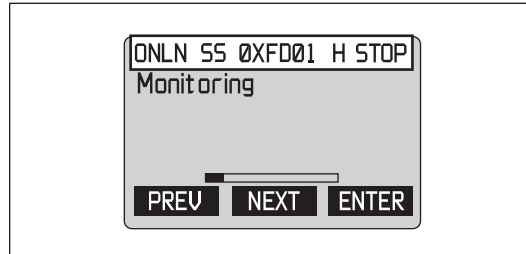

Figure G-7: Status Bar on LCD

Device Connection Status Text

This area is visible from the User Display screen. It represents the device that is actively being controlled (and typically will display "S811").

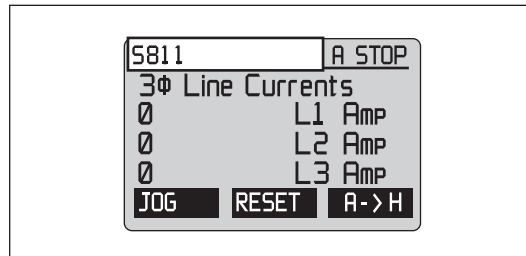

Figure G-8: Device Connection (User Display Only)

Connection Status

This represents whether the DIM is connected on the wire to other devices. This is viewable while navigating menus but not in User Display mode.

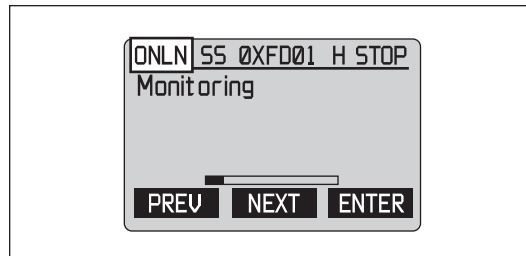

Figure G-9: Connection Status

OFLN — Offline — most likely the only device on the wire, with no other active device to talk to.

ONLN — Online — actively talking to another device. The normal mode of operation to be in.

FLT — Faulted mode — an internal communications fault has occurred.

UNDS – Undiscovered — the DIM has not yet entered into active communications with other devices. Most likely after a factory reset of the DIM (or if the DIM is in an out-of-the-box condition). Attaching to the S811 and cycling power to the system will correct this. On powerup the S811 will send commands to the DIM to reconfigure its communication, and the S811 will send a reset to the DIM after configuration is done (this process takes approximately 20 seconds).

Mode of Operation

Represents the communication protocol the DIM is configured to communicate using. This is viewable while navigating menus but not in User Display mode.

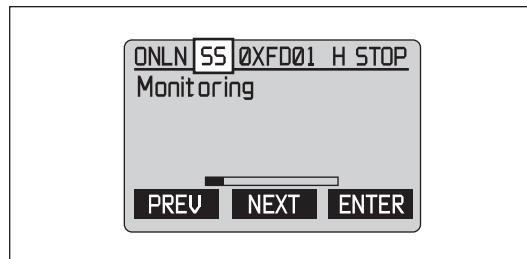

Figure G-10: Mode of Operation

UN — Unconfigured mode — the DIM has not yet been connected to an S811 that has configured it.

SS — Simple System — this is the typical configuration to be in when connected to the S811.

MS — Master Slave — this mode is not typically used for user interfaces. Master Slave is a mode used between the S811 and a Gateway.

WR — Wire Replacer — used for Digital Input/Output models.

ER — Error mode — an internal error has occurred.

November 2006

Connection Destination

This represents the Device ID that the DIM is connected to. Typically it will always reflect the Soft Start ID (**0xFD01**). This is viewable while navigating menus but not in User Display mode.

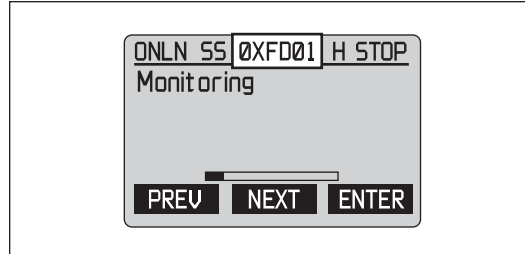

Figure G-11: Connection Destination

HAND/AUTO Status

This represents whether the system is in Hand (**H**) or Auto (**A**). If any device on the wire is asserting HAND, this status will reflect the S811 System Status of HAND.

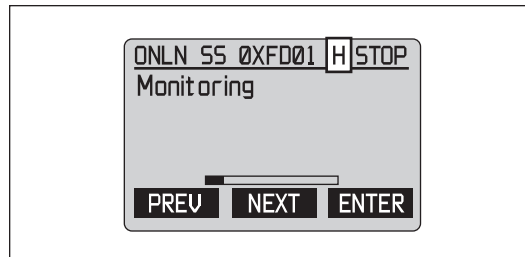

Figure G-12: HAND/AUTO Status

Motor Control Status

This represents the status of the S811 device (whether it is conducting current, stopped, faulted, etc.). It is visible on both the User Display and Edit modes.

RUN1 — S811 is in Run mode.

RUN2 — S811 is being actively Jogged.

STOP — S811 is not in Run mode, not being Jogged and not faulted.

FLT — S811 is faulted.

WARN — S811 has an active warning.

REF — S811 is At Reference (up to speed with bypass closed).

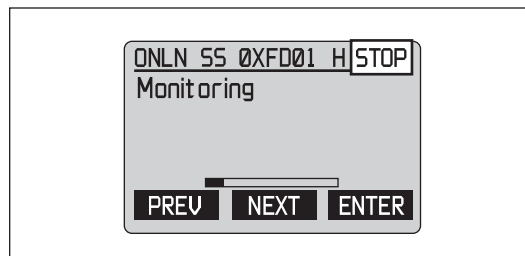

Figure G-13: Motor Control Status

Parameter Navigation/Editing

The ESCape key will take the DIM from the User Display screen to the Parameter Edit screens (as well as back to the User Display screen).

Menu Selection

The first screen allows the user to select the menu to edit. Note that the bar at the bottom will indicate the menu position in the list of all menus. A Soft Key under NEXT indexes through the menus forward, and a Soft Key under PREV (Previous) moves the DIM backwards through the menus.

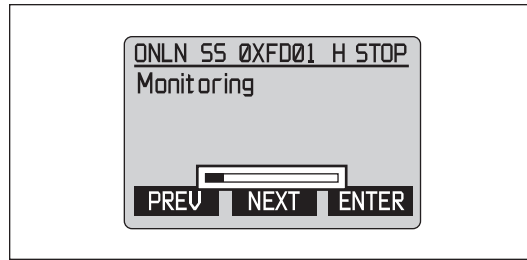

Figure G-14: Bar Indicates Menu Position

Pressing the Soft Key under ENTER will allow the user to select the item to view and possibly Edit. Note that the bar on the side will indicate the item position in the list of all Items.

Item Selection

Once a menu has been selected, the items within that menu can be scrolled through using the Soft Keys under NEXT and PREV. NEXT will index forward through the menu (causing the item bar to become larger), and PREV will cause it to index backward (causing the item bar to become smaller).

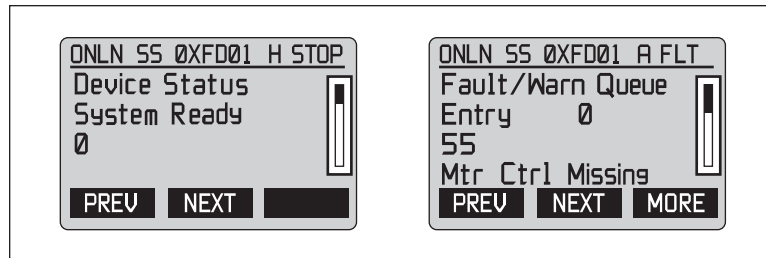

Figure G-15: Bar Indicates Item Position

November 2006

Read Write Operation

If a parameter is editable, the Soft Key under EDIT will be available on the lower right. Pressing EDIT will highlight an edit value that changes with INC and DEC, and also shows a bar that represents the edited value scaled between the min and max of that parameter.

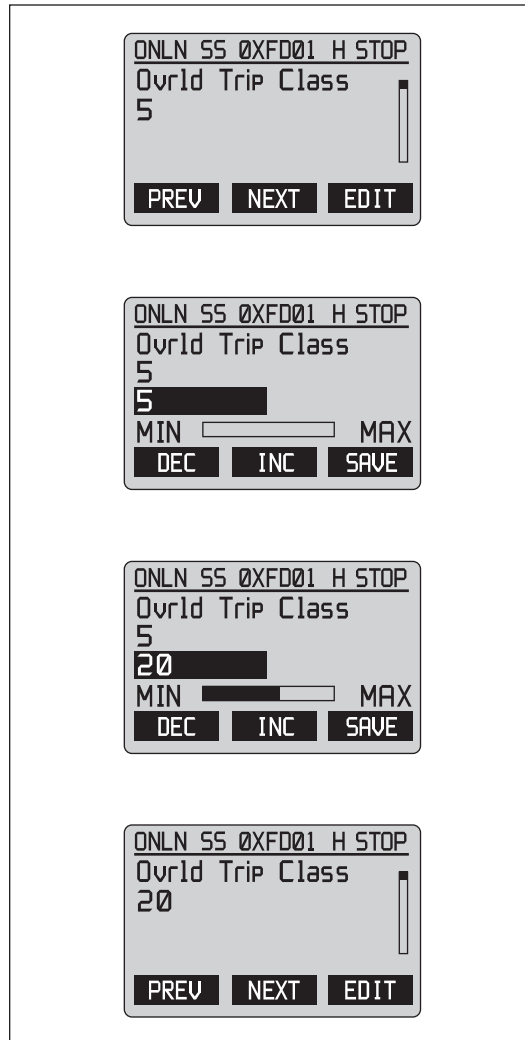

Figure G-16: Bar Indicates Edited Value

Parameters with Multiple Elements — Navigation and Editing

Some parameters have multiple elements. MORE will highlight the Element number, and NEXT and PREV will allow selection of which Element to view. In **Figure G-17**, the numerical value of Element 0 of the Fault Queue is the number 4.

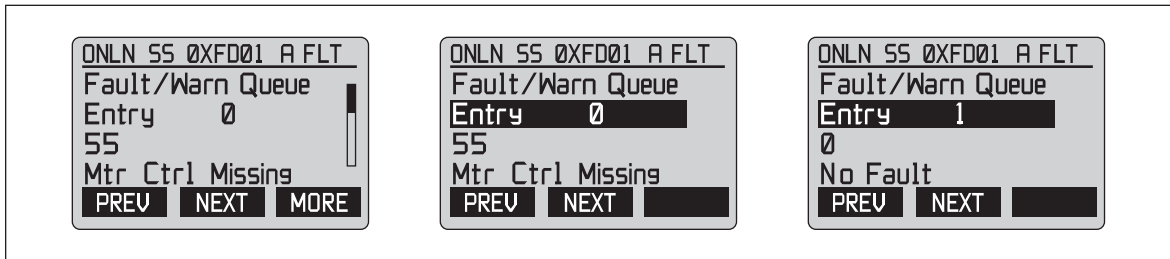

Figure G-17: Use MORE to Highlight Element

Enumerated Values

Some values have an alphanumeric text description as well as a numerical value. These values will be shown in addition to the internal numerical representation. For instance, Fault/Warning Queue Element 0 is a 4, which symbolically represents “Control Voltage Low.”

November 2006

Access Level (Password) Operation

The Access Level system restricts the editing (changing) of parameters to users who do not have the proper authorization. It has four levels that go from most restrictive (0) to full access (3). All parameters that are editable have an assigned **Access Level**, and the user of a DIM must unlock the DIM to that Access Level before the EDIT button is available.

To unlock the DIM to a level, the correct numerical value is entered, which is compared with the internal one stored in Eeprom. If the wrong password is entered, the Access Level is not increased. No Password is needed to go to a lower Access Level.

A Factory Reset starts the DIM out at Access Level 2 and sets the password for Access Level 1 and 2 to 0 (this allows users to go to level 1 and 2 without a password, until they initially enter a non-0 password). Once the user changes the password for a level, that number is valid for the future. There is no password stored nor needed for level 0.

The four levels of DIM Access Control are as follows:

Table G-1: Access Levels

Level Number	Description
Level 0	All parameters are Read Only.
Level 1	Basic Editing – values that a novice user is allowed to change.
Level 2	Advanced Editing – this level unlocks editing for virtually all of the S811 parameters. It is intended for system integrators. The DIM comes from the factory at this level, and a Factory Reset will set it back to this level.
Level 3	Available for CHESS service techs, factory configuration operation. A factory reset will not clear out the password that has been entered in to get to this level. Contact Eaton Customer Support for access to this level.

Note: The number of items in the LCD DIM Setup menu (parameters that are local to the DIM) will increase with higher Access Levels (more parameters on the local DIM menu will be visible). This is to expand complexity and the number of parameters for experienced users.

Set Access Level

A user can increase the Access Level of the DIM provided he has the password for that level. The default Password for levels 1 and 2 is 0, which does not need to be typed in to enter that level. A user can then assign a password with Change Password. All three levels have a hardcoded “back door” password. Contact Eaton Product Support for additional help.

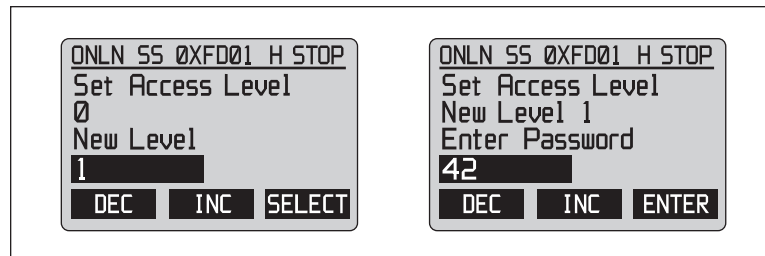

Figure G-18: Setting Access Level

Change Password for an Access Level

Once a user is at a specified access level, the password for that level and levels below it can be changed. This change will be saved to Eeprom.

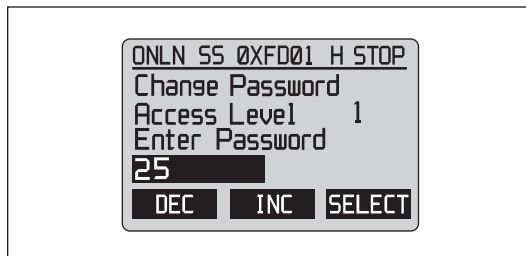

Figure G-19: Changing Passwords

Access Level Timeout is a numerical value that can be set to cause the DIM to go back to Level 0 after a specified period of inactivity. It can be set for between 60 seconds and 600 seconds, after which if no keys have been pressed the DIM will revert to Level 0. To disable this function, set the value to Max (600). If enabled, the DIM will always power up at Level 0.

Fault Display

If the DIM is on the User Display screen and a fault occurs on the S811, the DIM will reflect the fault with a bold overlay describing the fault textually. If the user is navigating menus, the fault overlay will not occur. In all instances, the upper right status area will display FLT. If the fault is cleared by some other remote device, or cleared by a terminal block Fault Clear, the fault overlay will go away by itself, and the DIM will go back to the User Display screen. A user can press the ESCape key, which will also put the DIM back to the User Display screen. The Fault is represented internally with the Faulted bit in the Motor Control Status byte.

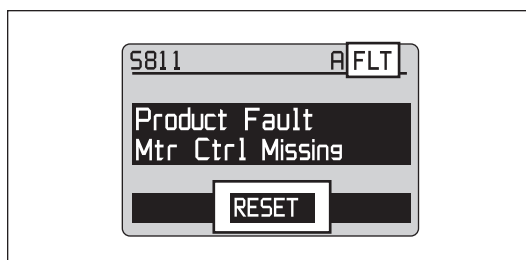

Figure G-20: Fault Display

See **Page 8-6** for a full listing of fault codes and corrective actions.

November 2006

DIM System Configuration



On its first powerup, the DIM is configured by the *IT*. Soft Starter to communicate several specific messages. The following communications between the S811 and DIM take place after power is energized (while the Eaton logo is displayed):

- The S811 commands the DIM to produce Motor Control command at the DIM's Production Interval.
- The S811 commands the DIM to consume Motor Control status at greater than the Consumption Interval.
- The DIM saves its Device ID and gets configured to the Simple System mode.

Multiple devices can be attached to the *IT*. Soft Starter (more than one DIM, a handle mechanism, etc.). If additional devices are added to a running system, the system may need to be re-configured to accommodate these devices.

A reconfiguration of all devices can be initiated using the following procedure from the DIM. See **Table G-2**.

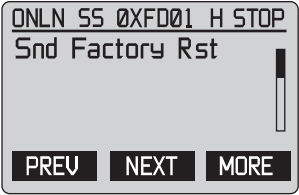
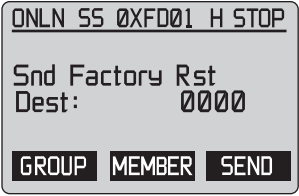
Table G-2: Reconfiguring All Devices

Step	Procedure	
1	Go to the LCD DIM Setup menu.	 <p>The screenshot shows the LCD DIM Setup menu. At the top, it displays 'ONLN SS 0XFD01 H STOP' and 'LCD DIM Setup'. At the bottom, there are three buttons: 'PREV', 'NEXT', and 'ENTER'.</p>
2	Select the Send Factory Reset parameter.	 <p>The screenshot shows the 'Snd Factory Rst' menu. At the top, it displays 'ONLN SS 0XFD01 H STOP' and 'Snd Factory Rst'. On the right side, there is a vertical scroll bar. At the bottom, there are three buttons: 'PREV', 'NEXT', and 'MORE'.</p>
3	Select MORE and press the SEND button. This broadcasts the Factory Reset to Device ID 0x0000, which causes all devices to reset.	 <p>The screenshot shows the 'Snd Factory Rst Dest: 0000' menu. At the top, it displays 'ONLN SS 0XFD01 H STOP' and 'Snd Factory Rst Dest: 0000'. At the bottom, there are three buttons: 'GROUP', 'MEMBER', and 'SEND'.</p>
4	The DIM and all other connected nodes on the Local port will begin an internal reconfiguration and within 10 seconds will reset.	 <p>The screenshot shows the Eaton Cutler-Hammer logo, consisting of the text 'EAT•N' above 'Cutler-Hammer'.</p>

A Reset Factory Defaults command will reconfigure the DIM to default values and will set the Level 1 and Level 2 passwords back to 0. It will not change the Serial Number and will not change the programmed Level 3 password.

DIM Setup Parameter Description

The LCD DIM has a number of Local parameters that can be adjusted to allow optimum operation. Some parameters may not be accessible if the DIM is unlocked to less than Access Level 3. Refer to **Table G-3** for access level necessary to view/modify parameters.

Table G-3: LCD DIM Setup Menu Access

Access Level 0	Access Level 1	Access Level 2	Access Level 3
Access Level	Access Level	Access Level	Access Level
Password	Password	Password	Password
			Access Timeout
			User Var 1
			User Var Scale 1
			User Var Descriptor 1
			User Var Units 1
			User Var Select 2
			User Var Scale 2
			User Var Descriptor 2
			User Var Units 2
Backlight Level	Backlight Level	Backlight Level	Backlight Level
Backlight Time	Backlight Time	Backlight Time	Backlight Time
Screen Contrast	Screen Contrast	Screen Contrast	Screen Contrast
		Scan For Devices	Scan For Devices
Identify Node	Identify Node	Identify Node	Identify Node
		Start Discovery	Start Discovery
		Reset-Soft	Reset-Soft
			Reset-Factory
		Reset-App Cfg	Reset-App Cfg
		Reset-App Fault	Reset-App Fault
		Reset-Commission	Reset-Commission
Clear Fault Queue	Clear Fault Queue	Clear FaultQueue	Clear Fault Queue
		Get Register	Get Register
			Set Register
			Run Delay
			Transient_Source
			Refresh Rate
Firmware Version	Firmware Version	Firmware Version	Firmware Version
	Term Resistors	Term Resistors	Term Resistors
		Inactive Timeout	Inactive Timeout
		Fault Disp Time	Fault Disp Time
			Production Data

November 2006

Table G-3: LCD DIM Setup Menu Access (Continued)

Access Level 0	Access Level 1	Access Level 2	Access Level 3
			Consumption Data
			Status
App Status	App Status	App Status	App Status
		Motor Control	Motor Control
		Motor Status	Motor Status
Device Temp Deg C	Device Temp Deg C	Device Temp Deg C	Device Temp Deg C
		Device Identity	Device Identity
		Config CRC	Config CRC
Node ID	Node ID	Node ID	Node ID
			Device mode
			Baud Rate
		Production Dest	Production Dest
Device ID Tag	Device ID Tag	Device ID Tag	Device ID Tag
			Production Intvl
			Consumption Intvl
Language List	Language List	Language List	Language List
Language Select	Language Select	Language Select	Language Select

Level 0

Access Level — See **Page G-11** — Access Level is a number between 0 and 3. The access level represents the restrictions on being able to edit and view settings (AKA password). Zero (0) is most restrictive and 3 is least restrictive. The Level 1 Default Password is 42 and the Level 2 Default Password is 4201.

Password — This allows a user to set the numerical password for the Access Level that they are on, as well as Access Levels below that. Using this parameter does not change the Default Password.

Backlight Level — The UI has a backlight that can be set to a value 0 – 3, 0 being Off and 3 being full On. If the LCD DIM Setup parameter Inactivity Timeout is set to non-0, a timeout will turn the display backlight off after this many seconds of non-activity (not pushing the switches for this many seconds).

Backlight Time — This value represents the number of seconds of inactivity before the backlight LEDs turn off. If set to 0, the backlight will remain on all the time.

Screen Contrast — This value adjusts the relative contrast of the LCD in the DIM. The default value should be good for most applications, and the DIM will adjust the contrast based on a high temperature. If the contrast has been adjusted to the point where the screen is no longer readable, simultaneously pressing the upper left, upper right, escape and stop keys will set the contrast back to the factory default setting.

Identify Node — send an identify command to a QCPort device.

Clear Fault Queue — This sends out a clear command over the wire to the Destination device(s) specified.

Firmware Version — This represents the firmware revision in Major-Minor format.

App Status — This represents the current Active Fault in the UI. Note that this may be a different value than the App Status found in the Motor Control menu (which represents the active fault in the S811).

Device Temp Deg C — This is the internal temperature of the LCD DIM in x.x Degrees C. This read-only parameter is used to auto-adjust the contrast at high temperature.

Node ID — The LCD DIM QCPort address, used for communications.

Device ID Tag — This is a string that describes the product.

Language List — A list of available languages for Text.

Language Select — Language the DIM is presently set to.

Level 1 (variables editable *IN ADDITION to the ones in Level 0*)

Term Resistors — This parameter turns on and off the termination resistors. In an RS-485 system only one device typically has termination resistors turned on. If a number of devices are on the *IT*. Soft Starter Local bus, consult factory regarding this parameter.

November 2006

Level 2 (variables editable IN ADDITION to the ones in Levels 0 and 1)

Scan For Devices — show a scan list of devices to communicate with.

Start Discovery — Send out a Discovery command to look for other devices.

Reset-Soft — Send a software reset to all devices selected within the address range specified.

Reset-App Cfg — This sends an Application Configuration Reset command to all devices selected within the address range specified.

Reset-App Fault — This sends an Application Fault Reset command to all devices selected within the address range specified.

Reset-Commission — This sends a Remote Commission Reset command to all devices selected within the address range specified.

Get Register — This is a mechanism to allow read access to internal product settings and parameters. Contact Factory Technical support for details.

Inactive Timeout — If this value is set to non-zero the UI will revert from the programming Menus back to the User Display menu after the set period of key inactivity. If this is set to 0, the feature is disabled.

Fault Disp Time — If this value is set to non-zero, the DIM will revert from the Fault Overlay popup back to the User Display menu after the set period of key inactivity. If this is set to non-0, the feature is disabled.

Motor Control — The bit command that the DIM is generating (the command that it sends to the S811).

Bit 0 – Run1

Bit 1 – Run2

Bit 2 – Permissive

Bit 3 – Fault Reset

Bit 4 – Local Control

Bit 5 – Local Control Capable Device

Motor Control Status —

Bit 0 – Running 1

Bit 1 – Running 2

Bit 2 – Permissive

Bit 3 – Reserved

Bit 4 – Local Control

Bit 5 – Faulted

Bit 6 – Warning

Bit 7 – At Reference

Device Identity — This array parameter consists of the following segments —

Byte 0-1 – Product Code

Byte 2-3 – Vendor ID

Byte 4-7 – Serial Number

Byte 8-9 – Hardware Version

Bytes 10-11 – Firmware Version

Bytes 12-13 – Protocol Version

Config CRC — A CRC check can be used to verify that the device at this node has a specific configuration and/or to guarantee that a node is being replaced with one that has similar characteristics.

Production Dest — This represents the Node that the DIM produces its Motor Control, and expects to receive its Motor Control Status from.

Note: For the commands above that allow commands to be sent to remote devices, the Default Device specified is 0x0000, which is a broadcast to clear the Fault Queue in all devices. The GROUP button increases the Group Address ID and the Member increases the member Address ID. The SEND button sends out the command.

Level 3 (variables editable IN ADDITION to the ones in Levels 0, 1 and 2)

Access Timeout — If the DIM pushbuttons are not actively manipulated for greater than this number of seconds, the DIM will revert back to level 0. Range 60 – 600 Seconds. Setting the parameter to 600 Seconds (max) disables the feature and lets the DIM stay at the current Level indefinitely.

Reset-Factory — This sends a Set Factory Defaults command to all devices selected within the address range specified.

Set Register — This is a mechanism to allow write access to internal product settings and parameters. Contact Factory Technical support for details.

Run Delay — This parameter specifies the duration that the START pushbutton has to be held down before the Start is recognized as valid (in tenths of a second). Setting this value to 0 will disable starts from the DIM.

Transient Source — If this value is set to 1 (enabled) the UI will be able to disconnect from a Controlling Node without causing a communications loss fault.

Refresh Rate — This parameter specifies the rate at which the data displayed on screen is refreshed from the remote source.

Device Mode — This reflects the mode that the DIM is using for communication (typically set to Simple System after the S811 initializes it). The DIM comes out of the box as Unconfigured.

Baud Rate — Set the rate at which QCPort communicates. Typically set to 57.6kBaud.

Production Intvl — This sets the rate at which DIM produces its data.

Consumption Intvl — This represents how long the DIM will wait after the last production from the S811 before issuing a communications loss fault.

November 2006

Appendix H — QCPort Network

QCPort Communication Wiring

QCPort is a protocol developed to provide communications between Eaton's Cutler-Hammer *IT* control products. Target applications range from simple communications to an operator interface to remote gateway scanning multiple devices. QCPort protocol was designed to provide:

- Low cost implementation
- Wire reduction
- "Out-of-box" functionality for simple systems
- PLC5-Class scanning performance for polled I/O applications

Complete QCPort application information is not covered in this manual. Contact your local Eaton representative or see *QCPort System Installation Manual MN0500010002E* for more information.

S811 Communications Ports

The S811 communicates using the QCPort protocol over RS-485. The S811 has three (3) communications ports supporting two separate QCPort networks. The first port is identified as "Channel 0 – Remote" and the remaining two ports as "Channel 1 – Local". All three ports use six conductor RJ11 (RJ12) type plugs.

QCPort Remote Network CH0 — The S811 remote network connection is isolated and designed to be connected to a gateway network. **The S811 remote port requires 24V to be supplied via network wiring.** The Node ID switch on the front of the S811 is used to set the node ID for this port.

QCPort Local Network CH1 (2 places) — The local network is designed to be connected to the DIM and other similar local devices. **The S811 local communications port supplies 24V to the local network wiring.** There is no node ID switch for the local port. The source of the local network power is the S811's main terminal block. The S811 has the local network termination resistors built-in and they are active by default.

One remote (CH0) and one local (CH1) network port connection is located on the S811's front cover near the field connector. The second local (CH1) port connection is located in the front cover pocket and is used to connect the DIM to the S811.

Set the remote network (CH0) group ID using the six switches labeled 32 ... 1 located on the front cover of the S811. When using the remote network you must make sure the remote network wiring supplies 24V to the S811's remote port.

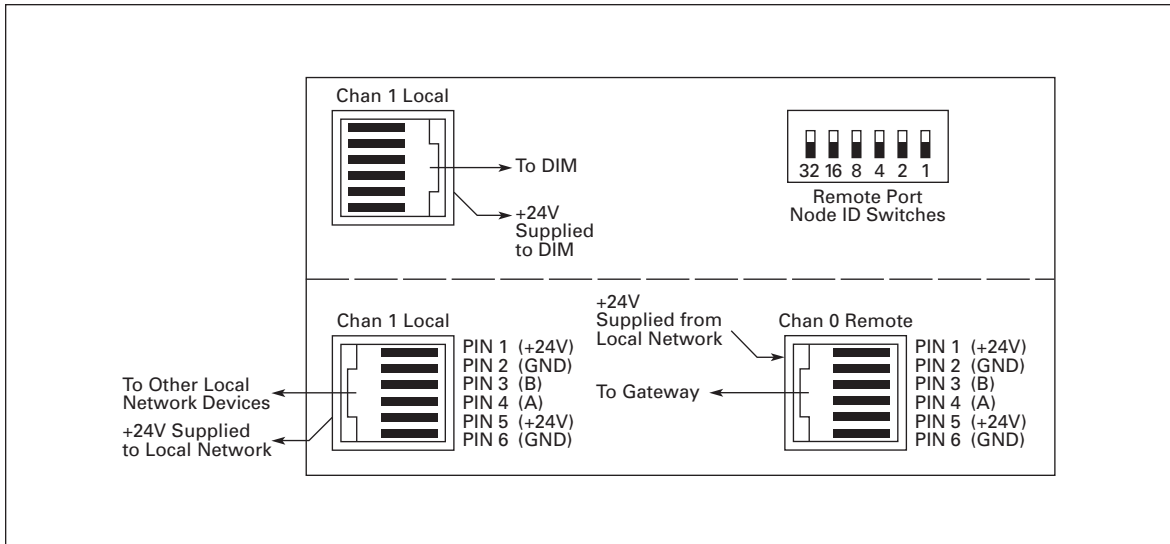

Figure H-1: QCP Network Wiring

November 2006

Networks

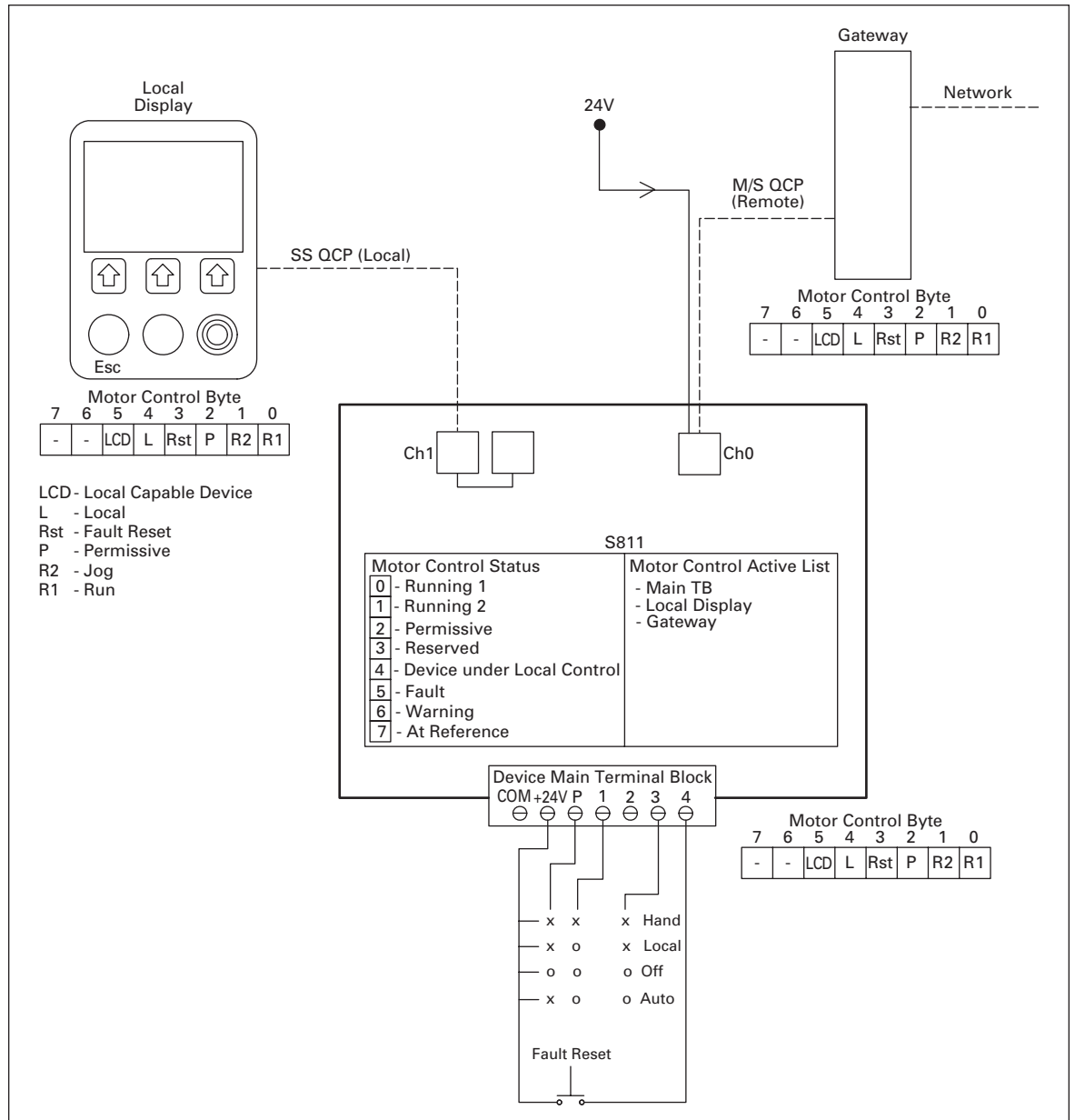

Figure H-2: Two-Wire QCPort System

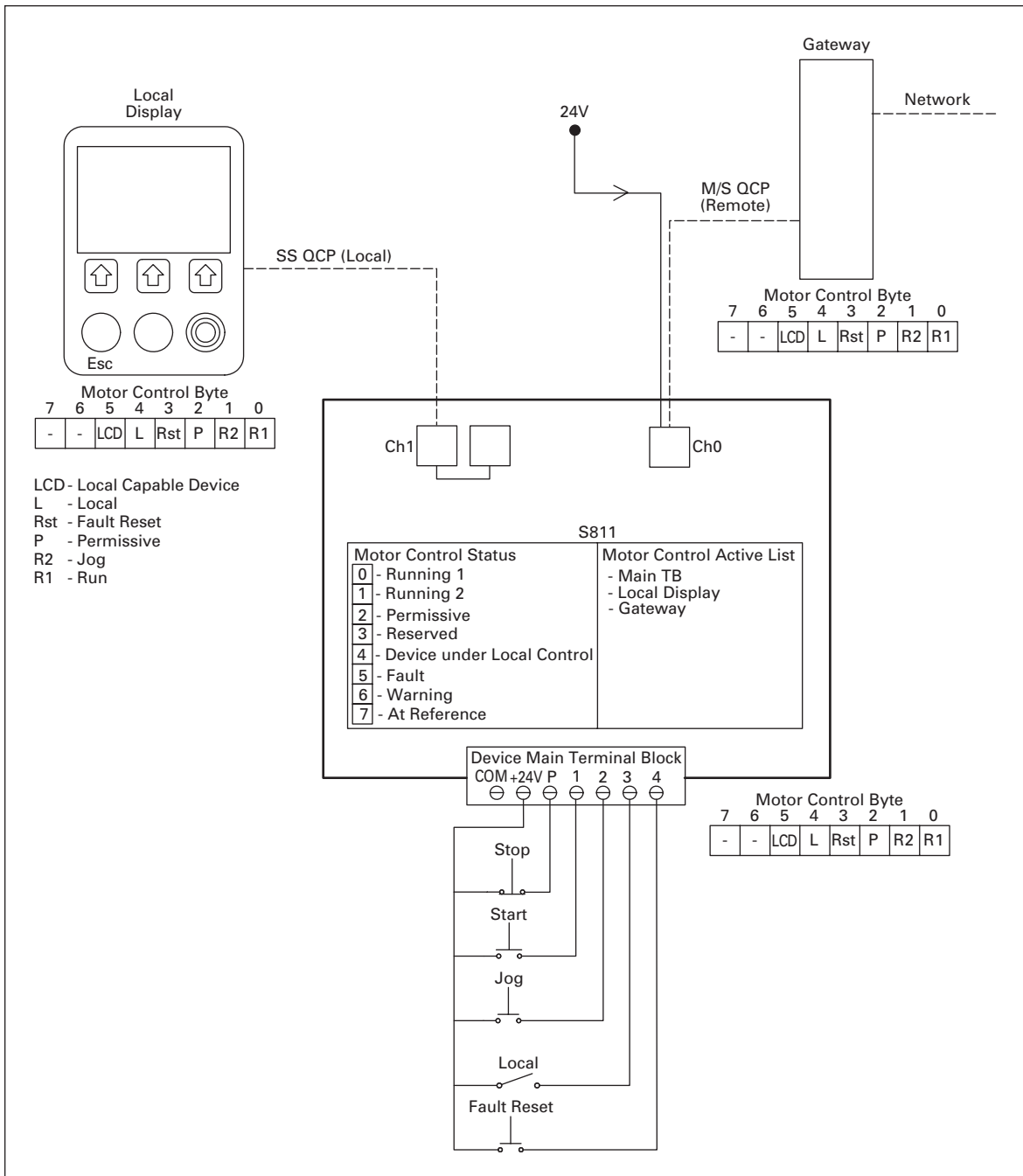

Figure H-3: Three-Wire QCPort System

November 2006

Auto and Hand/Local Modes

Auto mode of operation

- S811 responds to Motor Control commands from the network controller
- Selected when all Local devices have relinquished control (all L bit in their respective Motor Control bytes are 0)
- Note that:
 - All Local devices' Permissives must be set or S811 will stop.
 - Local Fault Resets can be performed.

Hand/Local mode of operation

- Removes the ability of network controller to Start or Stop the S811. Motor control can only be performed by Local devices (CH1 devices and Terminal Block).
- Note that:
 - Network controller can still monitor S811.

Network controller can perform a Remote Fault Reset.

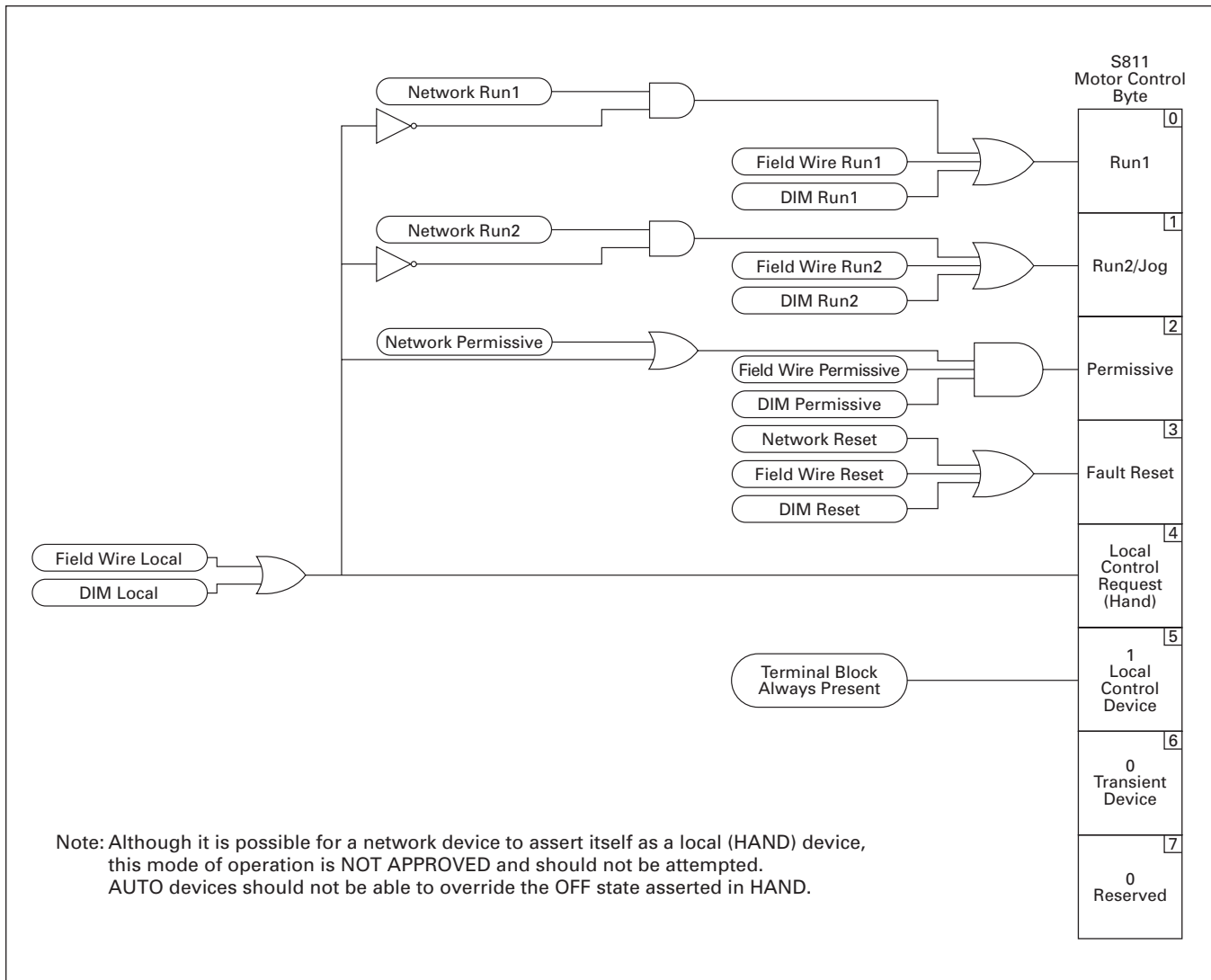

Figure H-4: S811 Motor Control Byte

November 2006

Appendix I — QCPort Parameter Descriptions

Below is a more detailed description of the S811 QCPort parameters. They are listed by parameter ID number and not as they appear in the S811 menu structure. Contact the Technical Resource Center, 1-800-356-1243 Option 3, for more information about QCPort parameters. Also, refer to QCPort System Install Manual MN05001001E for more information.

Data Parameters

- 0x0001 (1) Production Data**
Size: Varies
Description: This list contains the concatenated values of QCPort Parameters specified in QCPort Configuration Parameter 0x800C, Production List.
- 0x0002 (2) Consumption Data**
Size: Varies
Description: This list contains the concatenated values of QCPort Parameters specified in QCPort Configuration Parameter 0x800D, Consumption List.
- 0x0003 (3) QCPort Status**
Size: 1 byte
Description: This parameter indicates the QCPort fault condition that caused a device to enter the Fault Mode, as enumerated below:
0x00 – No QCPort Fault.
0x01 – Node ID Conflict
0x02 – Invalid Node ID in Master/Slave
0x03 – Physical Node ID does not match actual ID
0x04 – Duplicate configured nodes online.
0x05 – Dynamic Node ID overflow
0x06 – Invalid baud rate selected
0x07 – Errant Device fault
0x08 – Problem with data in non-volatile memory
- 0x0004 (4) Application Status**
Size: 2 bytes
Description: This parameter indicates the application status of the QCPort device. It reports the most recent fault or warning code. If there have been no faults or warnings, it reports 0. Reset clears this parameter.
- 0x000B (11) Motor Control**
Size: 1 byte
Description: One byte comprised of 8 bits assigned as follows:
0 – Run1
1 – Run2 / Jog
2 – Permissive
3 – Fault Reset
4 – Local Control Request (Not used in Master Slave mode)
5 – Local Control Device
6 – Transient Device
7 – Reserved

- 0x000C (12) Motor Control Status**
Size: 1 byte
Description: One byte comprised of 8 bits assigned as follows:
 0 – Running1
 1 – Running2
 2 – Permissive Active
 3 – Reserved
 4 – Device Under Local control
 5 – Faulted
 6 – Warning
 7 – At reference
- 0x000D (13) Motor Control Faults**
Size: 2 bytes
Description: Refer to **Appendix B** for a description of the Motor Protection Faults listed below.
 Two bytes comprised of 16 bits assigned as follows:
 Bit
 0 – Phase Loss
 1 – Phase Imbalance
 2 – Thermal Overload
 3 – Overcurrent
 4 – Breaker Trip
 5 – Ground Fault
 6 – Stall
 7 – Jam
 8 – Device Over Temperature
 9 – Underload
 10 – Reserved
 11 – E-Stop
 12 – Reserved
 13 – Reserved
 14 – Reserved
 15 – Other Fault - See Fault Code Table, **Page 8-6**.
- 0x000E (14) RMS AC Line Current (3 phase avg.) (% of FLA)**
Size: 2 bytes
Description: Unsigned integer representing the average of the three RMS line currents in % FLA
- 0x0012 (18) RMS AC Line Current (3 phase avg.) (Amps)**
Size: 4 bytes
Description: IEEE floating-point number representing the average of the three RMS line currents in amps.
- 0x0016 (22) DC Control Voltage (millivolts)**
Size: 2 bytes
Description: Unsigned integer representing voltage in millivolts.

November 2006

- 0x0017 (23) Thermal Memory (%)**
Size: 1 byte
Description: Unsigned integer representing thermal memory in percent. When the thermal memory value reaches 100% an Overload Fault will occur, if enabled. Other terms for this parameter include "thermal capacity" and "thermal pile". The value in the Thermal Memory parameter is an estimate of motor heating based on the magnitude and duration of current flowing through the motor.
- 0x0018 (24) Device Temperature (0.1 Deg C)**
Size: 2 bytes
Description: Signed integer representing internal device temperature in tenths of a degree Centigrade.
- 0x001A (26) Fault Queue**
Size: 20 bytes
Description: Faults are assigned numbers in the range 1 – 39,999. Warnings are assigned numbers 40,000 – 65,535.
The Fault Queue is a chronological listing of the 10 most recent faults and warnings. The most recent fault goes into Entry 0, shifting the current entries into the next highest entry. If the new fault was already in the queue, the oldest entry is deleted, the current entries are shifted to replace the deleted entry, and the new fault is placed into Entry 0. Duplicate fault codes will not occur in the queue.
See Fault Code Table, **Page 8-6**.
- 0x001B (27) 3 Phase RMS Line Currents (Amps)**
Size: 12 bytes
Description: Three 4-byte IEEE floating-point numbers representing the three RMS line currents in amps.
- 0x001C (28) 3 Phase RMS Pole Currents (Amps)**
Size: 12 bytes
Description: Three 4-byte IEEE floating-point numbers representing the three RMS pole currents in amps.
NOTE: That for inside-the-delta applications the Line and Pole currents will differ by a factor of approximately 3
- 0x001D (29) 3 Phase RMS AC Voltages (Volts)**
Size: 6 bytes
Description: Three 2 byte unsigned integers representing the three incoming line-to-line voltages: VL_{1-L2}, VL_{2-L3}, and VL_{3-L1}
- 0x001F (31) Total Number of Motor Starts**
Size: 4 bytes
Description: Unsigned double integer representing total starts since the unit was shipped from the factory.

0x0023 (35) Motor Control Warnings

Not supported in all versions of the S811 Soft Starter

Size: 2 bytes

Description: Two bytes comprised of 16 bits assigned as follows:

Bit

0 – Phase Loss

1 – Phase Imbalance

2 – Overload

3 – Over Current

4 – Breaker

5 – Ground fault

6 – Stall

7 – Jam

8 – Device Over Temperature

9 – Under Load

10 – Impending Trip (running current greater than 115% of FLA)

11 – E-Stop

12 – Reserved

13 – Reserved

14 – Reserved

15 – Other Warning - See Fault Code Table, **Page 8-6**.

0x0024 (36) Power Device Pole Temperature (°C)

Size: 6 bytes

Description: Three signed 16 bit integers representing pole temperatures in tenths degree Centigrade

0x0031 (49) Breaker Status

Cutler-Hammer communicating cover control or other communicating device is required to take advantage of this feature.

Size: 1 byte

Description: Reports the status of the circuit breaker.

One byte comprised of 8 bits assigned as follows:

Bit - Description

0 – Circuit Breaker On

1 – Circuit Breaker Tripped

2-6 – Reserved

7 – Circuit Breaker Unknown

0x005A (90) Average Scaled RMS Line Current (0.1 amps)

Size: 2 bytes

Description: A 2 byte unsigned integer value representing the average of the three RMS line currents in tenths of an amp.

A value of 65536 = 6553.6A.

0x005B (91) Average RMS Line Current (amps)

Size: 2 bytes

Description: A 2 byte unsigned integer value representing the average of the three RMS line currents in amps.

A value of 65536 = 65536A.

November 2006

- 0x005F (95) Average Scaled RMS Pole Current (0.1 amps)**
Size: 2 bytes
Description: A 2 byte unsigned integer value representing the average of the three RMS pole currents in tenths of an amp.
A value of 65536 = 6553.6A.
- 0x0060 (96) Average RMS Pole Current (amps)**
Size: 2 bytes
Description: A 2 byte unsigned integer value representing the average of the three RMS pole currents in amps.
A value of 65536 = 65536A.
- 0x0063 (99) Scaled 3 Phase RMS Line Currents (0.1 amps)**
Size: 6 bytes
Description: Three 2 byte unsigned integer values representing the three RMS line currents in tenths of an amp.
A value of 65536 = 6553.6A.
- 0x0064 (100) 3 Phase RMS Line Currents (amps)**
Size: 6 bytes
Description: Three 2 byte unsigned integer values representing the three RMS line currents in amps.
A value of 65536 = 65536A.
- 0x0067 (103) Scaled 3 Phase RMS Pole Currents (0.1 amps)**
Size: 6 bytes
Description: Three 2 byte unsigned integer values representing the three RMS pole currents in tenths of an amp.
A value of 65536 = 6553.6A.
NOTE: That for inside-the-delta applications the Line and Pole currents will differ by a factor of approximately $\sqrt{3}$
- 0x0068 (104) 3 Phase RMS Pole Currents (amps)**
Size: 6 bytes
Description: Three 2 byte unsigned integer values representing the three RMS pole currents in amps.
A value of 65536 = 65536A.
NOTE: That for inside-the-delta applications the Line and Pole currents will differ by a factor of approximately $\sqrt{3}$
- 0x0069 (105) Average RMS Pole Current (amps)**
Size: 4 bytes
Description: 4-byte IEEE floating-point number representing the average of the three RMS pole currents in amps.
NOTE: That for inside-the-delta applications the Line and Pole currents will differ by a factor of approximately $\sqrt{3}$
- 0x006D (109) Fault History**
Size: 20 bytes
Description: Faults are assigned numbers in the range 1 – 39,999. Warnings are assigned numbers 40,000 – 65,535.
The Fault History is a chronological listing of the 10 most recent faults and warnings. The most recent fault goes into Entry 0, shifting the current entries into the next highest entry. Duplicate fault codes will occur in this list.
See Fault Code Table, **Page 8-6**.

Configuration Parameters

None of the Configuration Parameters support I/O data.

- 0x8001 (32769) Device Identity**
Size: 14 bytes
Default: See below
Description: This read-only parameter contains information that uniquely identifies a device, including the following elements:
- | | |
|------------------------------------|---|
| Product Code (2 bytes) | 0x8200 |
| Vendor ID (2 bytes) | 0x0001 |
| Serial Number (4 bytes) | A device's serial number shall be reported. This value shall be unique for a particular manufacturer across all device types. |
| Hardware Revision (2 bytes) | Major revision shall be reported in the MSB. Minor revision shall be reported in the LSB. |
| Firmware Revision (2 bytes) | Major revision shall be reported in the MSB. Minor revision shall be reported in the LSB. |
| QCPort Revision (2 bytes) | Major revision shall be reported in the MSB. Minor revision shall be reported in the LSB. |
- 0x8002 (32770) Configuration CRC**
Size: 2 bytes
Default: N/A
Description: Used for confirmation of a device's configuration.
- 0x8003 (32771) Node ID**
Size: 2 bytes
Default: 0x0000
Description: This parameter specifies a device's Node ID. The Group ID is the Most Significant Byte and the Member ID is the Least Significant Byte.
- 0x8004 (32772) QCPort Operating Mode**
Size: 1 byte
Default: 0x00
Description: This parameter specifies a device's QCPort operating mode, as follows:
- | Mode | Description |
|-------------|--------------------|
| 0x00 | Unconfigured |
| 0x01 | Simple System |
| 0x02 | Master/Slave |
| 0x03 | Wire Replacer |
| 0x04 | Faulted |

November 2006

- 0x8005 (32773) Baud Rate**
Size: 1 byte
Default: 0x03
Description: This parameter specifies the QCPort baud rate for a device as indicated below:
0x00 – 9600
0x01 – 19,200
0x02 – 38,400
0x03 – 57,600
0x04 – 115,200
0x05 – 230,400
0x06 – 460,800
- 0x8006 (32774) Slave Address**
Size: 1 byte
Default: 0x00
Description: This parameter specifies the address used by a Master for data transfers in the Master/Slave Data Protocol.
- 0x8007 (32775) Production Destination**
Size: 2 bytes
Default: 0x0000
Description: This parameter specifies the destination Node ID being used by an S811 Local port device communicating in the Simple System Protocol. The MSB indicates the Group ID; the LSB indicates the Member ID.
- 0x8008 (32776) Device ID Tag**
Size: 32 bytes
Default: S811
Description: This parameter specifies the 32-character ASCII string ID tag assigned to a device, pre-assigned at the factory but settable by the user.
- 0x8009 (32777) Production Interval (milliseconds)**
Size: 2 bytes
Default: 50
Description: This parameter specifies the rate, in milliseconds, at which a Local port producing device generates a Data Protocol message in the Simple System mode.
A value of 0 disables this timer.
- 0x800A (32778) Consumption Interval (milliseconds)**
Size: 2 bytes
Default: 2000
Description: This parameter is the value in milliseconds to which the consumption timer is preset upon receipt of a set (value update) to any parameter on the *Consumption List*.
Expiration of this timer shall cause the device to execute the *Motor Communications Loss Behavior*.
A value of 0 disables this timer.

- 0x800B (32779) Parameter List**
Size: 2n bytes
Default: N/A
Description: This read-only list specifies the n QCPort parameters that the S811 Soft Starter supports.
- 0x800C (32780) Production List**
Size: n bytes
Default: 0x000C
Description: This 2n-byte read-only list specifies the n QCPort Parameters included in a device's QCPort Data Parameter 0x0001, *Production Data*.
Adding parameters to the *Production List* is most conveniently done using CH Studio Component Manager configuration tool. Otherwise, setting Parameter Attribute 0x09, "Production List Member", to TRUE, designates a Parameter's membership in the *Production List*. Only Parameters supporting Attribute 0x09 are eligible for inclusion in this list.
Ordering of parameters in the *Production List* is first on parameter data size and then sequentially by Parameter ID within parameters of like size.
- 0x800D (32781) Consumption List**
Size: n bytes
Default: 0x000B
Description: This 2n-byte read-only list specifies the n QCPort Parameters included in a device's QCPort Data Parameter 0x0002, *Consumption Data*.
Adding parameters to the *Consumption List* is most conveniently done using CH Studio Component Manager configuration tool. Otherwise, setting Parameter Attribute 0x09, "Production List Member", to TRUE, designates a Parameter's membership in the *Consumption List*. Only Parameters supporting Attribute 0x09 are eligible for inclusion in this list.
Ordering of parameters in the *Consumption List* is first on parameter data size and then sequentially by Parameter ID within parameters of like size.
- 0x800E (32782) Languages Supported**
Size: n bytes
Default: N/A
Description: This is a list of languages supported in the product. It consists of a list of bytes, each representing a different language.
0x00 English
0x01 Spanish
0x02 French
0x03 German
0x04 Italian
- 0x800F (32783) Language Selection**
Size: 1 byte
Default: 0x00
Description: Holds the currently selected language from the list in parameter 800E.

November 2006

- 0x8010 (32784) Device Semaphore**
Size: 4 bytes
Default: N/A
Description: The purpose of this parameter is to provide a method for tools to access a QCPort node in a non-conflicting manner. This parameter consists of a field of 2 UINTs organized as follows:
Byte
Node ID Low byte
Node ID High byte
Lockout Time in tenths of seconds Low byte
Lockout Time in tenths of seconds High byte
If the above 4 bytes are 0, anyone can write to this parameter. This parameter cleared by the Clear Semaphore command that can be sent by anyone. If all 4 bytes are not 0 and a write (other than a clear) to this parameter is attempted, an error message will be returned. The parameter will be cleared when the timer counts down to 0.
If the node ID field is 0, all set parameters to the node will be accepted. If the node ID field is not 0, set parameter commands to the node will only be accepted from the device having the same node ID as that contained in this parameter. Note that if the node ID is set to zero at the same time that a non-zero value is loaded to the timer, the timer will not decrement.
- 0x8020 (32800) Overload Trip FLA Value (amps)**
Size: 4 bytes
Default: Device dependent. Minimum specified value for specific S811 frame.
Description: IEEE floating point value of Full Load Amps (FLA) in amps.
- 0x8021 (32801) Overload Trip Class Value**
Size: 1 byte
Default: 5
Description: Unsigned integer specifies motor trip class. Typically associated with motor protection. See **Page B-3** for trip class curves.
- 0x8022 (32802) Percent Initial Torque (T2) (% LRT)**
Size: 1 byte
Default: 25
Description: Unsigned integer intended for use primarily with a soft starter. Specifies the starter's initial torque (T2) in percent.
- 0x8025 (32805) Soft Start Time (tr) (0.1 seconds)**
Size: 2 bytes
Default: 20.0 sec
Description: Unsigned integer sets the duration of the start ramp in tenths of a second.
- 0x8026 (32806) Soft Stop Time (ts) (0.1 seconds)**
Size: 2 bytes
Default: 0.0
Description: Sets the duration of the stop ramp in tenths of a second.

- 0x8030 (32816) Undercurrent Fault Trip Level (%FLA)**
Size: 1 byte
Default: 6%
Description: Unsigned integer. Currents below this threshold (as a percent of FLA) that persist for greater than 2 seconds will cause an Underload fault.
- 0x803B (32827) Motor Jam Fault Enable**
Size: 1 byte
Default: 1 (Enabled)
Description: Enables Jam Fault detection.
- 0x803F (32831) Motor Stall Fault Enable**
Size: 1 byte
Default: 1 (Enabled)
Description: Enables Stall Fault detection
- 0x8043 (32835) Phase Loss Fault Enable**
Size: 1 byte
Default: 1 (Enabled)
Description: Enables Phase Loss Fault detection
- 0x8044 (32836) Phase Imbalance Fault Enable**
Size: 1 byte
Default: 1 (Enabled)
Description: Enables Phase Imbalance Fault detection
- 0x8045 (32837) Kick Start Torque (% LRT)**
Size: 1 byte
Default: 0
Description: 1 byte unsigned integer representing *Kick Start Torque* setting in Percent
- 0x8046 (32838) Kick Start Time (0.1 seconds)**
Size: 1 byte
Default: 0
Description: 1 byte unsigned integer representing *Kick Start Time* in tenths of seconds.
- 0x8048 (32840) Overload Fault Enable**
Size: 1 byte
Default: 1 (Enabled)
Description: 0 – Disables Overload Fault trip until next 24V DC power cycle. Thermal memory continues to accumulate.
1 – Enables Overload Fault protection
- 0x8049 (32841) Phase Reversal Fault Enable**
Size: 1 byte
Default: 1
Description: Enables Phase Reversal Fault detection. A Phase Reversal Fault occurs when the incoming line phase rotation does not match the setting of the *Phase Sequence* parameter.

November 2006

- 0x804A (32842) Auto Reset Enable**
Size: 1 byte
Default: 0 (Disabled)
Description: Enables the auto fault reset function. An auto reset will be performed after the thermal memory has cooled below 75% and all other fault conditions have been corrected. This parameter is displayed as *Reset Mode* in the DIM
- 0x804B (32843) Start Method**
Size: 1 byte
Default: 0
Description: Unsigned integer which sets the S811's starting method:
0x00 – Voltage Ramp Start
0x01 – Current Limit Start
0x02 – Reserved
0x03 – Pump Start (option)
0x04 – Reserved
- 0x804E (32846) Motor Communication Loss Action**
Size: 1 byte
Default: 0x00
Description: Determines motor action in the event of a communications timeout in network communications. This parameter only applies when the node is on line and in Auto mode. The following values are allowed:
0x00 = Auto Stop – go to auto and stop
0x01 = Auto Run1 – go to auto and Run1 ¹
0x02 = Auto Run2 – go to auto and Run2 ¹
0x03 = Hold Last – hold last state
0x04 = Local Stop – go to local and stop
0x05 = Local Run1 –go to local and Run1 ¹
0x06 = Local Run2 – go to local and Run2 ¹
0x07 = All Stop (fault)– leave in last control mode (local or auto) and stop ²
Note 1: Warning, these actions may cause the S811 to start once network communications are restored.
Note 2: All Stop causes a fault and needs a reset to clear.
- 0x804F (32847) Motor Rated Volts (volts)**
Size: 2 bytes
Default: 480 volts
Description: Unsigned integer set to match the incoming line voltage. This setting calibrates the Over Voltage and Under Voltage Faults
- 0x806C (32876) Firmware Version List**
Size: 4 bytes
Default: N/A
Description: Unsigned integer identifies firmware versions of all firmware components of the S811. Consists of 2 2-byte elements.
- 0x806D (32877) Hardware Version List**
Size: 2 bytes
Default: N/A
Description: Hardware version of all components of the system

- 0x807C (32892) Current Imbalance Fault Level (%)**
Size: 1 byte
Default: 40%
Description: Unsigned integer sets the current imbalance trip level where:
Percent Current Imbalance = $100 * (\text{max deviation from average} / \text{average})$
Current is continuously being monitored for imbalance while the motor is energized.
- 0x807D (32893) Current Imbalance Fault Duration/Delay (0.1 seconds)**
Size: 2 bytes
Default: 0.5 Sec
Description: Unsigned integer sets duration in tenths of seconds that a current imbalance condition must persist before a fault is generated.
- 0x807F (32895) Voltage Imbalance Fault Level (%)**
Size: 1 byte
Default: 6%
Description: Unsigned integer sets the voltage imbalance trip level where:
Percent Voltage Imbalance = $100 * (\text{max deviation from average} / \text{average})$
Voltage is checked for imbalance prior to initiating a each start.
- 0x8080 (32896) Voltage Imbalance Fault Duration/Delay (0.1 seconds)**
Size: 2 bytes
Default: 0.5 Sec
Description: Unsigned integer sets duration in tenths of seconds that a voltage imbalance condition must persist before a fault is generated.
- 0x8082 (32898) Under Voltage Fault Enable**
Size: 1 byte
Default: 1 (Enabled)
Description: Enables Under Voltage Fault.
The S811 monitors the minimum RMS value of the incoming three phase voltages. The unit will trip if the *Under Voltage Fault* is enabled and the minimum RMS value drops below the *Under Voltage Fault Level* or 80V AC, whichever is greater, for longer than the *Under Voltage Fault Duration*. Note that the S811 will not generate an under voltage trip when the motor is starting. The fault is only active when the unit is operating in bypass.
- 0x8085 (32901) Under Voltage Fault Duration /Delay (0.1 seconds)**
Size: 2 bytes
Default: 3.0 Sec
Description: Unsigned integer sets duration in tenths of seconds that an under voltage condition must persist before a fault is generated.

November 2006

0x8087 (32903) Over Voltage Fault Enable**Size:** 1 byte**Default:** 1 (Enabled)**Description:** Enables Over Voltage Fault detection.

The S811 monitors the maximum RMS value of the three phase voltages. The unit will trip with an Over Voltage Fault if the *Over Voltage Fault* is enabled and the maximum RMS value rises above the *Over Voltage Fault Level* for longer than the *Over Voltage Fault Duration*.

0x8089 (32905) Over Voltage Fault Duration /Delay (0.1 seconds)**Size:** 2 bytes**Default:** 3.0 sec**Description:** Unsigned integer sets duration in tenths of seconds that an over voltage condition must persist before an Over Voltage Fault is generated.**0x80AD (32941) Transient Motor Control Timeout (milliseconds)****Size:** 2 bytes**Default:** 2000 milliseconds**Description:** Unsigned integer.

A QCPort device on the Local port is identified as a transient motor control device when the Transient Device bit (bit 6) in its *Motor Control* byte is SET. Transient motor control devices that are removed from the Local port will not cause a Motor Control Command Fault. A transient motor control timer is monitored to verify the presence of the transient motor control device. This timer is preset to the *Transient Motor Control Timeout* value each time the S811 receives another *Motor Control* byte with the Transient Device bit SET. When the timer times out, indicating that the device has been removed from the network, the S811 will clear and ignore that device's Motor Control byte.

DO NOT SET THE *TRANSIENT MOTOR CONTROL TIMEOUT* TO 0. Doing so will disable the Transient Motor Control Timeout until the next Factory Reset.

0x80B4 (32948) Phase Sequence**Size:** 1 byte**Default:** 0**Description:** Unsigned integer sets the acceptable incoming line phase sequence. *Phase Reversal Fault* must be enabled.

0 – ABC

1 – ACB

0x80B6 (32950) Phase Loss Trip Level (%)**Size:** 1 byte**Default:** 80% of Rated Voltage**Description:** Unsigned integer sets Percent Imbalance = $100 * (\text{max deviation from average} / \text{average})$

The S811 monitors the current imbalance when the motor is running. Phase loss is an extreme case of current imbalance. The unit will trip with a motor phase loss fault if the phase loss trip is enabled and the percent imbalance exceeds the trip threshold for the trip delay and current is greater than the Overload Trip FLA.

- 0x80B8 (32952) Phase Loss Duration/Delay (0.1 seconds)**
Size: 2 bytes
Default: 0.5 sec
Description: Unsigned integer sets duration in tenths of seconds that a phase loss condition must persist before a Phase Loss Fault is generated.
- 0x80C0 (32960) Motor Control Command Missing Timeout (milliseconds)**
Size: 2 bytes
Default: 2000 milliseconds
Description: Unsigned integer.
Every device that produces a *Motor Control* byte gets a timer assigned to it. When a device fails to refresh its *Motor Control* byte the timer will expire. When the timeout occurs, a Missing Motor Control Device Fault is generated.
- 0x80C3 (32963) Temperature Sensor Fault Enable**
Size: 1 byte
Default: 1 (Enabled)
Description: Enables temperature sensor failure detection. Temperature Sensor Fault indicates that sensor has failed either by being disconnected or reporting an invalid temperature.
- 0x80C4 (32964) SCR Not Firing Fault Enable**
Size: 1 byte
Default: 1 (Enabled)
Description: Enables detection of SCR (thyristor) failure to conduct current when fired (gated)
- 0x80C5 (32965) SCR Shorted Fault Enable**
Size: 1 byte
Default: 1 (Enabled)
Description: Enables shorted SCR detection.
- 0x80C6 (32966) Input Level Sense Enable**
Size: 1 byte
Default: 1 (Enabled)
Description: Enables DC voltage level detection at the S811 Run1 terminal block input.
0 – Run1 Edge Sensing
1 – Run1 Level Sensing
- 0x80C8 (32968) Under Voltage Fault Level (%)**
Size: 1 byte
Default: 90% Motor Rated Volts
Description: Unsigned integer.
The S811 monitors the minimum RMS value of the incoming three phase voltages. The unit will trip if the *Under Voltage Fault* is enabled and the minimum RMS value drops below the *Under Voltage Fault Level* or 80V AC, whichever is greater, for longer than the *Under Voltage Fault Duration*. Note that the S811 will not generate an under voltage trip when the motor is starting. The fault is only active when the unit is operating in bypass.

November 2006

- 0x80C9 (32969) Over Voltage Fault Level (%)**
Size: 1 byte
Default: 110% Motor Rated Volts
Description: Unsigned integer.
The S811 monitors the maximum RMS value of the three phase voltages. The unit will trip with an Over Voltage Fault if the *Over Voltage Fault* is enabled and the maximum RMS value rises above the *Over Voltage Fault Level* for longer than the *Over Voltage Fault Duration*.
- 0x80CA (32970) Output Relay 1 Configuration**
Size: 1 byte
Default: 2
Description: Unsigned integer. Configures functionality of Relay 1:
0 – Faulted
1 – Not Faulted (Ready)
2 – In Bypass
3 – Not In Bypass (Starting)
4 – Motor Energized
5 – Motor Not Energized
- 0x80CB (32971) Output Relay 2 Configuration**
Size: 1 byte
Default: 0
Description: Unsigned integer. Configures functionality of Relay 2:
0 – Faulted
1 – Not Faulted (Ready)
2 – In Bypass
3 – Not In Bypass (Starting)
4 – Motor Energized
5 – Motor Not Energized
- 0x80CC (32972) Overload During Start Enable**
Size: 1 byte
Default: 1 (Enabled)
Description: 0 – Overload disabled during start. Thermal memory is set to 80% when bypass entered.
1 – Overload enabled during start
- 0x80CD (32973) Pump Stop Time (0.1 seconds)**
Size: 2 bytes
Default: 120.0 sec
Description: Unsigned integer. Sets the Stop Ramp Time for S811s with the pump control option.
- 0x80CE (32974) Termination Resistor Enable**
Size: 1 byte
Default: 1 (Enabled)
Description: Connects termination resistor at S811 Local port (CH1).

Company Information

Eaton's electrical business is a global leader in electrical control, power distribution, and industrial automation products and services. Through advanced product development, world-class manufacturing methods, and global engineering services and support, Eaton's electrical business provides customer-driven solutions under brand names such as Cutler-Hammer®, Powerware®, Durant®, Heinemann®, Holec® and MEM®, which globally serve the changing needs of the industrial, utility, light commercial, residential, and OEM markets. For more information, visit www.EatonElectrical.com.

Eaton Corporation is a diversified industrial manufacturer with 2005 sales of \$11.1 billion. Eaton is a global leader in electrical systems and components for power quality, distribution and control; fluid power systems and services for industrial, mobile and aircraft equipment; intelligent truck drivetrain systems for safety and fuel economy; and automotive engine air management systems, powertrain solutions and specialty controls for performance, fuel economy and safety. Eaton has 60,000 employees and sells products to customers in more than 125 countries. For more information, visit www.eaton.com.

Eaton Electrical Inc.
1000 Cherrington Parkway
Moon Township, PA 15108-4312
USA
tel: 1-800-525-2000
www.EatonElectrical.com

EAT•N

Cutler-Hammer

© 2006 Eaton Corporation
All Rights Reserved
Printed in USA
Publication No. MN03902002E/CPG
November 2006 — Revision 6